

# KENWOOD

AUDIO VIDEO SURROUND RECEIVER

## VR-510

---

## INSTRUCTION MANUAL

KENWOOD CORPORATION

### ***About the supplied remote control***

Compared to standard remote controls, the remote control supplied with this receiver has several operation modes. These modes enable the remote control to control other audio/video components. In order to effectively use the remote control it is important to read the operating instructions and obtain a proper understanding of the remote control and how to switch its operation modes (etc.).

Using the remote control without completely understanding its design and how to switch the operation modes may result in incorrect operations.

# Before applying the power

 **Caution : Read this page carefully to ensure safe operation.**

This unit is designed for operation as follows.

- U.S.A. and Canada ..... **AC 120 V only**
- Australia ..... **AC 240 V only**
- Europe and U.K. .... **AC 230 V only**
- China and Russia ..... **AC 220 V only**
- \*Other countries ..... **AC 110 - 120/220 - 240 V switchable**

## Unpacking

Unpack the unit carefully and make sure that all accessories are put aside so they will not be lost.

Examine the unit for any possibility of shipping damage. If your unit is damaged or fails to operate, notify your dealer immediately. If your unit was shipped to you directly, notify the shipping company without delay. Only the consignee (the person or company receiving the unit) can file a claim against the carrier for shipping damage.

We recommend that you retain the original carton and packing materials for future use should you transport or ship the unit in the future.

**Keep this manual handy for future reference.**

## Safety precautions

### WARNING :

TO PREVENT FIRE OR ELECTRIC SHOCK, DO NOT EXPOSE THIS APPLIANCE TO RAIN OR MOISTURE.

### Accessories

FM indoor antenna (1)



AM loop antenna (1)

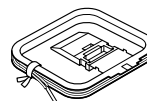

RF remote antenna (1)



Remote control unit (1)  
RC-R0812

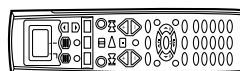

Batteries (R6/AA) (4)

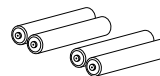

#### CAUTION

RISK OF ELECTRIC SHOCK  
DO NOT OPEN



CAUTION: TO REDUCE THE RISK OF ELECTRIC SHOCK, DO NOT REMOVE COVER (OR BACK). NO USER-SERVICEABLE PARTS INSIDE, REFER SERVICING TO QUALIFIED SERVICE PERSONNEL.



THE LIGHTNING FLASH WITH ARROWHEAD SYMBOL, WITHIN AN EQUILATERAL TRIANGLE, IS INTENDED TO ALERT THE USER TO THE PRESENCE OF UNINSULATED "DANGEROUS VOLTAGE" WITHIN THE PRODUCT'S ENCLOSURE THAT MAY BE OF SUFFICIENT MAGNITUDE TO CONSTITUTE A RISK OF ELECTRIC SHOCK TO PERSONS.



THE EXCLAMATION POINT WITHIN AN EQUILATERAL TRIANGLE IS INTENDED TO ALERT THE USER TO THE PRESENCE OF IMPORTANT OPERATING AND MAINTENANCE (SERVICING) INSTRUCTIONS IN THE LITERATURE ACCOMPANYING THE APPLIANCE.

**For the U.S.A.**

**FCC WARNING**

This equipment may generate or use radio frequency energy. Changes or modifications to this equipment may cause harmful interference unless the modifications are expressly approved in the instruction manual. The user could lose the authority to operate this equipment if an unauthorized change or modification is made.

**NOTE:**

This equipment has been tested and found to comply with the limits for a Class B digital device, pursuant to Part 15 of the FCC Rules. These limits are designed to provide reasonable protection against harmful interference in a residential installation. This equipment may cause harmful interference to radio communications, if it is not installed and used in accordance with the instructions. However, there is no guarantee that interference will not occur in a particular installation. If this equipment does cause harmful interference to radio or television reception, which can be determined by turning the equipment off and on, the user is encouraged to try to correct the interference by one or more of the following measures:

- Reorient or relocate the receiving antenna.
- Increase the separation between the equipment and receiver.
- Connect the equipment into an outlet on a circuit different from that to which the receiver is connected.
- Consult the dealer or an experienced radio / TV technician for help.

**For the U.S.A.**

**Note to CATV system installer:**

This reminder is provided to call the CATV system installer's attention to Article 820-40 of the NEC that provides guidelines for proper grounding and, in particular, specifies that the cable ground shall be connected to the grounding system of the building, as close to the point of cable entry as practical.



As an ENERGY STAR® Partner, Kenwood Corporation has determined that this product meets the ENERGY STAR® guidelines for energy efficiency.

This product can save energy. Saving energy reduces air pollution and lowers utility bills.

**Maintenance of the unit**

When the front panel or case becomes dirty, wipe with a soft, dry cloth. Do not use thinner, benzine, alcohol, etc. for these agents may cause discoloration.

**In regard to contact cleaner**

Do not use contact cleaners because it could cause a malfunction. Be specially careful not to use contact cleaners containing oil, for they may deform the plastic component.

**Contents**

**Caution : Read the pages marked ⚠ carefully to ensure safe operation.**

	⚠ <b>Before applying the power</b> .....	<b>2</b>
	⚠ Safety precautions .....	2
	Unpacking .....	2
	How to use this manual .....	4
	Special features .....	4
	<b>Names and functions of parts</b> .....	<b>5</b>
	Remote control unit .....	6
	<b>Setting up the system</b> .....	<b>7</b>
	Connecting audio components .....	8
	Connecting video components .....	9
	Digital connections .....	10
	Connecting video components (COMPONENT VIDEO) .....	11
	Connecting a DVD player (6-channel input) .....	12
	Connecting the speakers .....	13
	Connecting the terminals .....	14
	Connecting to another room (ROOM B) .....	15
	PRE OUT connections .....	16
	Connecting the RF antenna, external IR Receiver and external IR Repeater .....	17
	Connecting to the AV AUX jacks .....	18
	Connecting the antennas .....	18
	RF remote control function .....	19
	Connecting the system control .....	20
	How to use the display operation keys .....	21
	<b>Preparing for surround sound</b> .....	<b>22</b>
	Speaker settings .....	22
	<b>Normal playback</b> .....	<b>24</b>
	Preparing for playback .....	24
	Listening to a source component .....	24
	Adjusting the sound .....	25
	<b>Recording</b> .....	<b>26</b>
	Recording audio (analog sources) .....	26
	Recording video .....	26
	Recording audio (digital sources) .....	26
	<b>Listening to radio broadcasts</b> .....	<b>27</b>
	Tuning radio stations .....	27
	Presetting radio stations manually .....	27
	Receiving preset stations .....	27
	Receiving preset stations in order (P.CALL) .....	28
	<b>Ambience effects</b> .....	<b>29</b>
	Surround modes .....	29
	Surround play .....	32
	DVD 6-channel playback .....	33
	Convenient functions .....	33
	<b>Remote control operations</b> .....	<b>36</b>
	Registering setup codes for other components .....	36
	Operating other components .....	37
	Changing (confirming) the operation mode .....	38
	Preparing for automatic operations (MACRO play) .....	38
	Executing an automatic operation .....	39
	To delete the setup code .....	40
	Storing the remote control code of the other components .....	40
	Restoring the original factory settings .....	41
	Displaying the CD TEXT data .....	42
	<b>Remote control operation of other components</b> .....	<b>43</b>
	<b>In case of difficulty</b> .....	<b>49</b>
	⚠ <b>Specifications</b> .....	<b>51</b>

Preparations

Operations

Remote Control

Additional Information

Preparations

Operations

Remote Control

Additional Information

## How to use this manual

This manual is divided into four sections: Preparations, Operations, Remote Control, and Additional Information.

### Preparations

Shows you how to connect your audio and video components to the receiver and prepare the surround processor.

We will guide you to make setting up your system as easy as possible. However, since this receiver works with all of your audio and video components, connecting the system can be fairly complex.

### Operations

Shows you how to operate the various functions available from the receiver.

### Remote Control

Shows you how to operate other components using the remote control, as well as a detailed explanation of all remote control operations. Once you have registered your components with the proper setup codes, you'll be able to operate both this receiver and your other AV components (TV, VCR, DVD player, LD player, CD player, etc.) using the remote control supplied with this receiver.

### Additional Information

Shows you additional information such as "In case of difficulty" (troubleshooting) and "Specifications".

## Special features

### True home theater sound

This receiver incorporates a wide variety of surround modes to bring you maximum enjoyment from your video software. Select a surround mode according to your equipment or the software you are going to play and enjoy!

— [29]

### Home THX Cinema

THX Select incorporates a complex multichannel digital audio program materials such as Dolby Digital, PRO LOGIC & DTS which enables multichannel decoding.

This system features Re-equalization (Re-EQ), Timbre Matching, Adaptive Decorrelation, Bass Peak Level Manager and Loudspeaker Position Time Synchronization, which reproduces similar cinematic effects in the home environment.

### Dolby Digital

The DOLBY DIGITAL mode lets you enjoy full digital surround from software processed in the Dolby Digital format. Dolby Digital provides up to 5.1 channels of independent digital audio for better sound quality and more powerful presence than conventional Dolby Surround.

### Dolby Pro Logic II

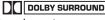
DOLBY PRO LOGIC II, whilst totally compatible with its predecessor PRO LOGIC, provides greater advantage in surround sound. It allows the users to enjoy the conventional stereo or Dolby Surround with a convincing "5.1 like" presentation. PRO LOGIC II offers special features for controlling the overall spatial, dimensionality, and frontal sound field imaging. PRO LOGIC II produces an impressive surround sound from video software marked  and three-dimensional space from music CD. When listening to music, you will be able to enjoy the experience of sheer STEREO surround sound.

### Dolby 3 Stereo

This surround system reproduces theater-like surround sound from video software marked .

The 3 STEREO mode will redirect the Surround signal to the front left and right speakers when only the front and center speakers are used.

### DTS

DTS (Digital Theater System) is a 5.1 channel digital audio format that provides five full-spectrum channels and one low-frequency (subwoofer) channel for unprecedented clarity, optimum channel separation and a (wide) dynamic range.

In the DTS mode, the 5.1 channel digital input from a DTS CD, LD or DVD disc (carrying the "DTS" marking) can be played in Digital Surround.

Important:

When a DTS disc is played on a CD, LD or DVD player, noise may be output from the analog output. It is recommended that you connect the digital output of the player to the digital input of this unit.

### Multi channel music (SRS Circle Surround CS)

SRS Circle surround enables you to listen to multi channel sound from the stereo source. We assume you have already enjoyed listening to Dolby digital sound/DTS multi channel sound with your multi speakers. Now, this time try listening to the stereo source (ex. Audio CD) using your multi speakers. You may discover a new type of "stereo" sound through SRS Circle Surround.

### DSP surround modes

The DSP (Digital Signal Processor) used for this receiver incorporates a variety of high quality adjustable sound fields, like "ARENA", "JAZZ CLUB", "THEATER", "STADIUM" and "DISCO". It is compatible with almost any kind of program source.

### DVD 6-channel input

If you own a DVD player equipped with 6-channel output, this receiver allows you to obtain the full surround sound impact of DVD source material featuring multi-channel encoding. Since the source signals are digital and each channel is input independently, the resulting ambience is far superior to what can be achieved with conventional surround sound systems.

### Remote control

This remote control has two kinds of signal-

#### Universal IR (InfraRed) remote signal

In addition to the basic receiver, the remote control supplied with this receiver can also operate almost all of your remote controllable audio and video components. Just follow the simple setup procedure to register the components you have connected.

#### RF remote signal

You can operate the receiver by sending RF remote signal from the remote control. The controllable range of the remote control is not influenced by surroundings such as distance or an obstruction.

#### MACRO play

The MACRO function lets you perform a series of operations automatically, like turning ON the power of the receiver and connected components, switching the input selectors, and starting playback. (Be sure to register your components before starting the macro set up procedure).

### Memory back up function

Please note that the following items will be deleted from the unit's memory if the power cord is disconnected from the AC outlet for approximately 2 days.

- Power mode.
- Input selector settings.
- Device preset.
- Picture output.
- Speaker ON/OFF
- Volume level.
- BASS, TREBLE, INPUT level.
- Subwoofer ON/OFF.
- Dimmer level.
- Monitor ON/OFF.
- MD/TAPE settings.
- 6ch/2ch input setting.
- Listen mode setting.
- Speaker settings.
- Input mode setting.
- Midnight mode setting.
- Broadcast band.
- Frequency setting.
- Preset stations.
- Tuning mode.
- Source Direct.
- RF Band.
- THX.
- SW RE-MIX.
- Bass Peak Level.

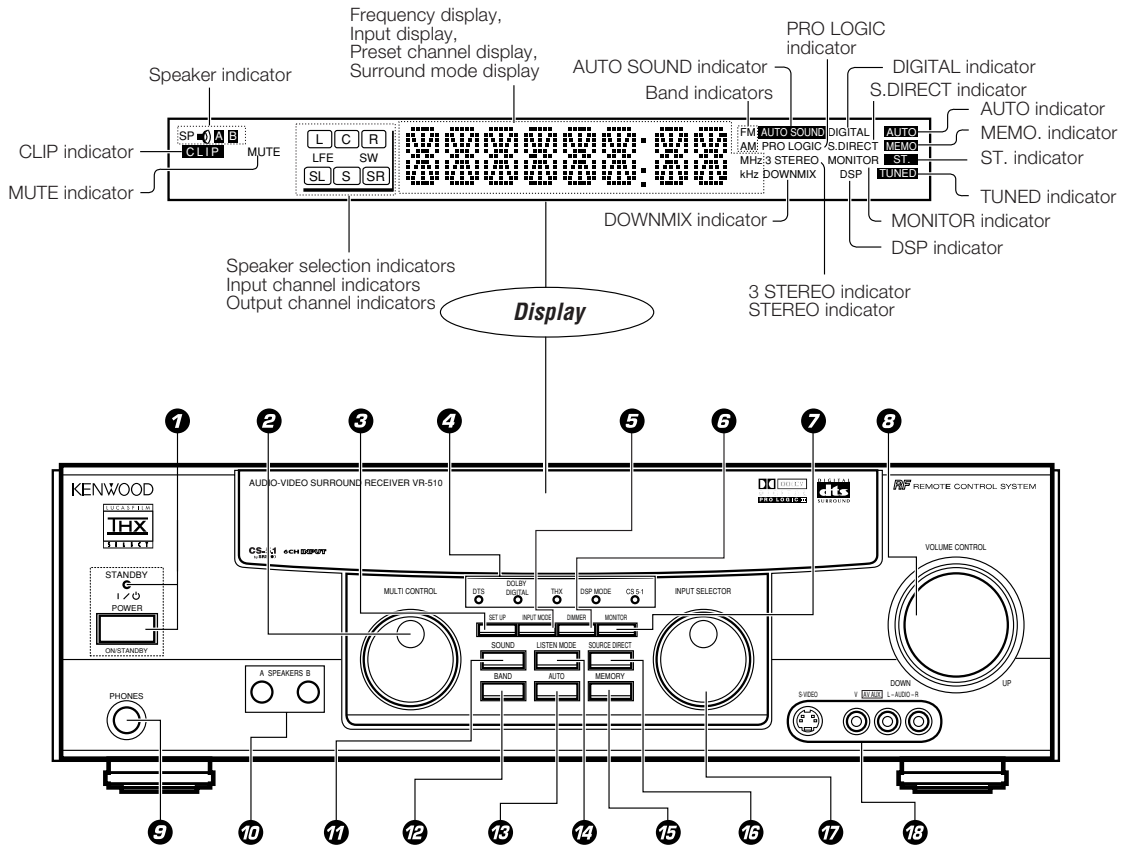

- 1 POWER (I/O) key** - [22]  
Use to switch the power ON/STANDBY.  
**STANDBY indicator**
- 2 MULTI CONTROL knob** - [22]  
Use to control a variety of settings.
- 3 SET UP key** - [22]  
Use to select the speakers' settings etc.
- 4 Surround indicators**  
**DTS indicator** - [32]  
Lights when the receiver is in the DTS mode.  
**DOLBY DIGITAL indicator** - [32]  
Lights when the receiver is in the Dolby Digital mode.  
**THX indicator** - [25]  
Lights when the receiver is in the THX mode.  
**DSP MODE indicator** - [32]  
Lights when the receiver is in the DSP mode.  
**CS 5.1 indicator** - [32]  
Lights when the receiver is in the CS 5.1 mode.
- 5 INPUT MODE key** - [27]  
Use to switch between the digital and analog inputs.
- 6 DIMMER key**  
Use to adjust the brightness of the display. - [35]  
Use to select the REC MODE. - [26]
- 7 MONITOR key** - [26]  
Use to monitor the source that is connected to the MONITOR jack.
- 8 VOLUME CONTROL knob** - [24]
- 9 PHONES jack** - [25]  
Use for headphone listening.
- 10 SPEAKERS A/B keys** - [24]  
Use to turn the A/B speakers ON/OFF.
- 11 SOUND key** - [25]  
Use to adjust the sound quality and ambience effects.
- 12 BAND key** - [27]  
Use to select the broadcast band.
- 13 AUTO** - [24]  
Use to change "TAPE" indication to "MD". - [24]  
Use to select the auto tuning mode. - [27]
- 14 LISTEN MODE key** - [34]  
Use to select the listening mode.
- 15 MEMORY key** - [27]  
Use to store radio stations in the preset memory.
- 16 SOURCE DIRECT key** - [25]  
Use to pass the source material direct to the amplifier.
- 17 INPUT SELECTOR knob** - [24]  
Use to select the input sources.
- 18 AV AUX (S VIDEO, V, AUDIO L/R) jacks** - [18]

## Standby mode

When standby indicator is lit, this receiver is in standby mode and consumes a small amount of current for back-up. This system can be switched on using remote control.

6 Remote control unit

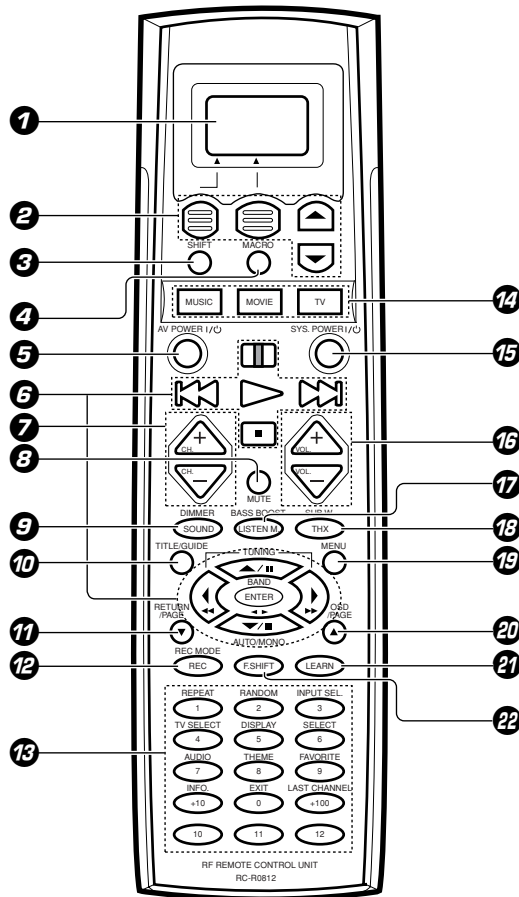

If the name of a function is different on the receiver and on the remote control, the name of the remote control key in the manual is indicated in parentheses.

- 1 **Display** - [21]
- 2 **Display operation keys** - [21]  
Use for operation on the display.
- 3 **SHIFT key** - [37]  
Use in combination with the MUSIC and MOVIE keys to change the remote control mode without changing the input selector.
- 4 **MACRO key** - [38]  
Use in combination with the MUSIC, MOVIE, or TV keys to execute a series of commands automatically (MACRO PLAY).
- 5 **AV POWER I/⏻ key** - [37]  
Use to turn various components on and off.
- 6 **Multi control keys** - [40]  
Use to control a variety of settings.  
Use to operate other components.
- 7 **CH +/- keys** - [40]  
Use to select the channel.
- 8 **MUTE key** - [25]  
Use to temporarily mute the sound.
- 9 **SOUND key** - [25]  
Use to adjust the sound quality and ambience effects.  
**DIMMER key (with F.SHIFT key)** - [35]  
Use to adjust the brightness of the display.
- 10 **TITLE/GUIDE key** - [40]  
Use to operate other components.
- 11 **▼ key**  
Use to operate other components.  
**RETURN/PAGE key** - [40]  
Use to operate other components.

- 12 **REC key** - [40]  
Use to operate the selected component.  
**REC MODE key**  
Use to select the REC MODE.
- 13 **Numeric keys/Source operation keys** - [27]  
Provide functions identical to those of the original remote control supplied with the component you are controlling.  
To access the functions printed above the keys, press the numeric key after pressing the F. SHIFT key. Function availability varies for each component.
- 14 **MUSIC key** - [24]  
Selects the audio inputs and sets the remote control to operate the component registered at the respective input.  
If you connect audio components from KENWOOD and other makers to the MD/TAPE or CD jacks, you can set the remote control to operate these components by registering the appropriate setup code at the respective input.  
**MOVIE key** - [24]  
Selects the video inputs and sets the remote control to operate the component registered at the respective input.  
**TV key** - [37]  
Sets the remote control to operate a TV or cable box. This key does not change the input selector on the receiver.

- 15 **SYS. POWER I/⏻ key** - [22]  
Use to turn the receiver on and off.
- 16 **VOL. +/- keys** - [24]  
Use to adjust the receiver volume.
- 17 **LISTEN M. key** - [32]  
Use to select the listening mode.  
**BASS BOOST key (with F. SHIFT key)** - [25]  
Use to select the maximum adjustment setting for the low frequency range.
- 18 **THX key** - [25]  
Use to switch the status of THX.  
**SUB W. key (with F. SHIFT key)** - [35]  
Use in combination with the volume +/- keys to adjust the volume of the subwoofer.
- 19 **MENU key**  
Use to operate other components.
- 20 **▲ key**  
Use to operate other components.  
**OSD/PAGE key** - [40]  
Use to operate other components.
- 21 **LEARN key** - [40]  
Use to memorize the operation of the other remote control units.
- 22 **F. SHIFT key** - [25]  
Use in combination with the numeric keys to execute alternate commands.  
Turn the light of the display on and off by pressing and holding this key for more than 2 seconds.

# Setting up the system

Make connections as shown on the following pages. When connecting the related system components, be sure to also refer to the instruction manuals supplied with the components you are connecting. Do not connect the power cord to a wall outlet until all connections are completed.

## DTS disclaimer clause

DTS Digital Surround™ is a discrete 5.1 channel digital audio format available on CD, LD, and DVD software which consequently cannot be decoded and played back inside most CD, LD, or DVD players. For this reason, when DTS-encoded software is played back through the analog outputs of the CD, LD, or DVD player, excessive noise will be exhibited. To avoid possible damage to the audio system, proper precautions should be taken by the consumer if the analog outputs are connected directly to an amplification system. To enjoy DTS Digital Surround™ playback, an external 5.1 channel DTS Digital Surround™ decoder system must be connected to the digital output (S/P DIF, AES/EBU, or TosLink) of the CD, LD or DVD player.

## Notes

1. Be sure to insert all connection cords securely. If their connections are imperfect, the sound may not be produced or noise may interfere.
2. Be sure to remove the power cord from the AC outlet before plugging or unplugging any connection cords. Plugging/unplugging connection cords without disconnecting the power cord can cause malfunctions and may damage the unit.
3. Do not connect power cords from components which power consumption is larger than what is indicated on the AC outlet at the rear of this unit.

## Analog connections

Audio connections are made using RCA pin cords. These cables transfer stereo audio signal in an "analog" form. This means the audio signal corresponds to the actual audio of two channels. These cables usually have 2 plugs on each end, one red for the right channel and one white for the left channel. These cables are usually packaged with the source unit, or are available at your local electronics retailer.

## Microcomputer malfunction

If operation is not possible or an erroneous display appears, even though all connections have been made properly, reset the microcomputer referring to "In case of difficulty". - [49]

## CAUTION

Be sure to adhere to the followings, or proper ventilation will be blocked causing damage or fire hazard.

- Do not place any objects impairing heat radiation onto the top of unit.

## Input mode settings

CD/DVD, DVD/6ch, VIDEO2 and VIDEO3 inputs each include jacks for digital audio input and analog audio input.

You must select beforehand which type of input is to be used for each connected component.

The initial factory settings for audio signal playback (CD/DVD, DVD/6ch) and (VIDEO2, VIDEO3) are digital and analog respectively.

To use the analog audio input for playback instead (if, for example, you have connected a VCR to the VIDEO2 or VIDEO3 input), you must set the input mode for the corresponding input to the analog mode.

After completing connections and turning on the receiver, follow the steps below.

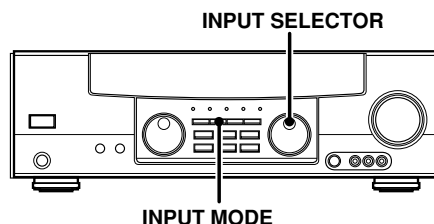

- 1 Use the INPUT SELECTOR knob to select CD/DVD, DVD/6ch, VIDEO2, or VIDEO3.

- 2 Press the INPUT MODE key.

Each press switches the setting as follows:

### In DTS play mode

- 1 D-AUTO (digital input, auto sound)
- 2 D-MANUAL (digital input, manual sound)

### In DVD/6ch play mode

- 1 D-AUTO (digital input, auto sound)
- 2 D-MANUAL (digital input, manual sound)
- 3 6ch INPT (DVD/6ch input)
- 4 ANALOG (analog input, manual sound)

### In modes other than DTS or DVD/6ch play mode

- 1 D-AUTO (digital input, auto sound)
- 2 D-MANUAL (digital input, manual sound)
- 3 ANALOG (analog input, manual sound)

### Digital input:

Select this setting to play digital signals from a DVD, CD, or LD player.

### Analog input:

Select this setting to play analog signals from a cassette deck, VCR, or turntable.

### Auto sound:

In the auto sound mode (AUTO SOUND indicator lights), the receiver selects the listening mode automatically during playback to match the type of input signal (Dolby Digital, PCM, DTS) and the speaker setting. The initial factory setting is auto sound on.

To keep the receiver set to the currently selected listening mode, use the INPUT MODE key to select "D-MANUAL" (manual sound). However, even when this setting is selected, there may be cases in which the listening mode is selected automatically to match a Dolby Digital source signal depending on the combination of listening mode and source signal.

If the INPUT MODE key is pressed quickly, sound may not be produced.

# Connecting audio components

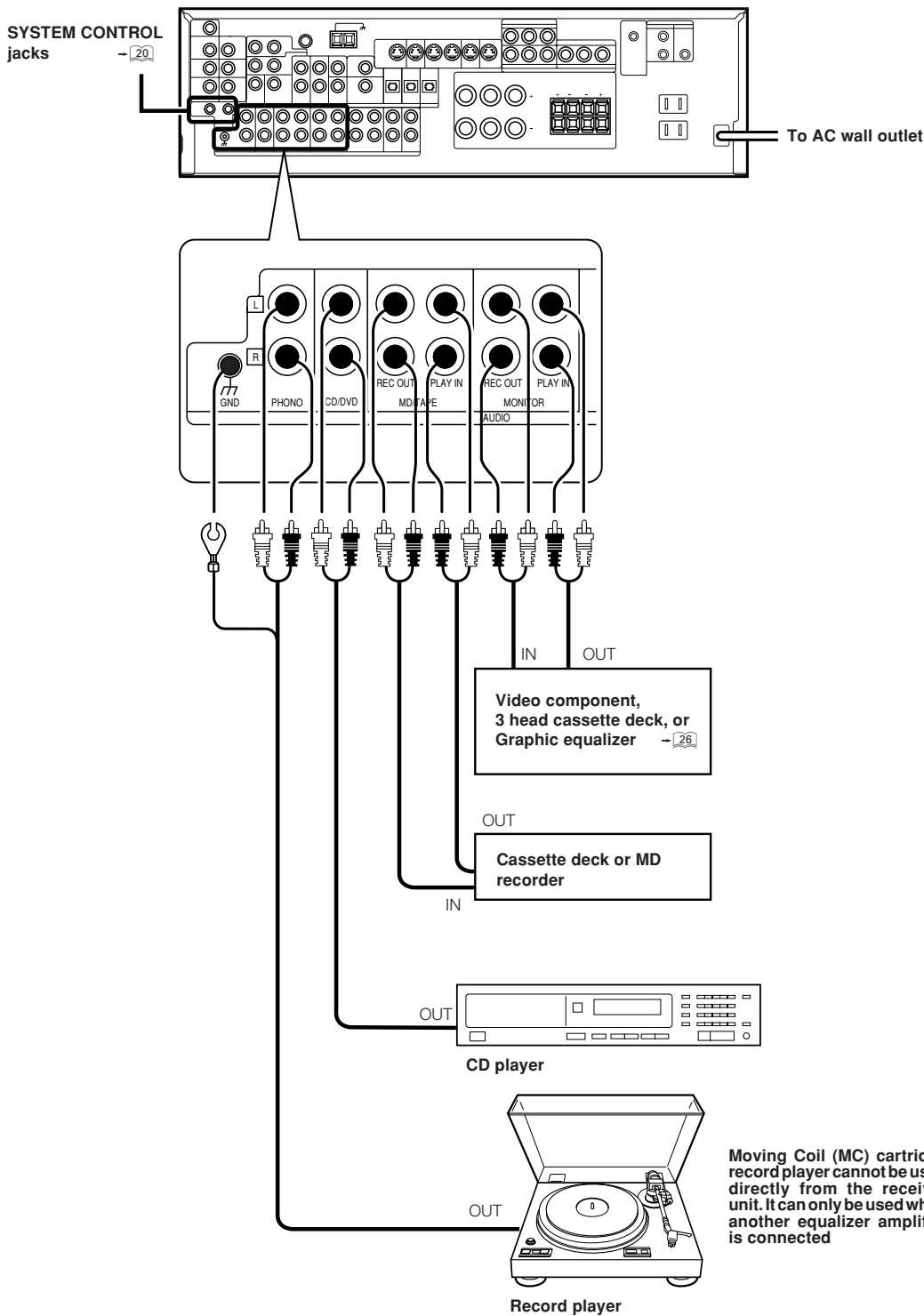

When you connect the unit and the CD or MD player with the digital connection, you can enjoy a better sound quality.



# Connecting video components

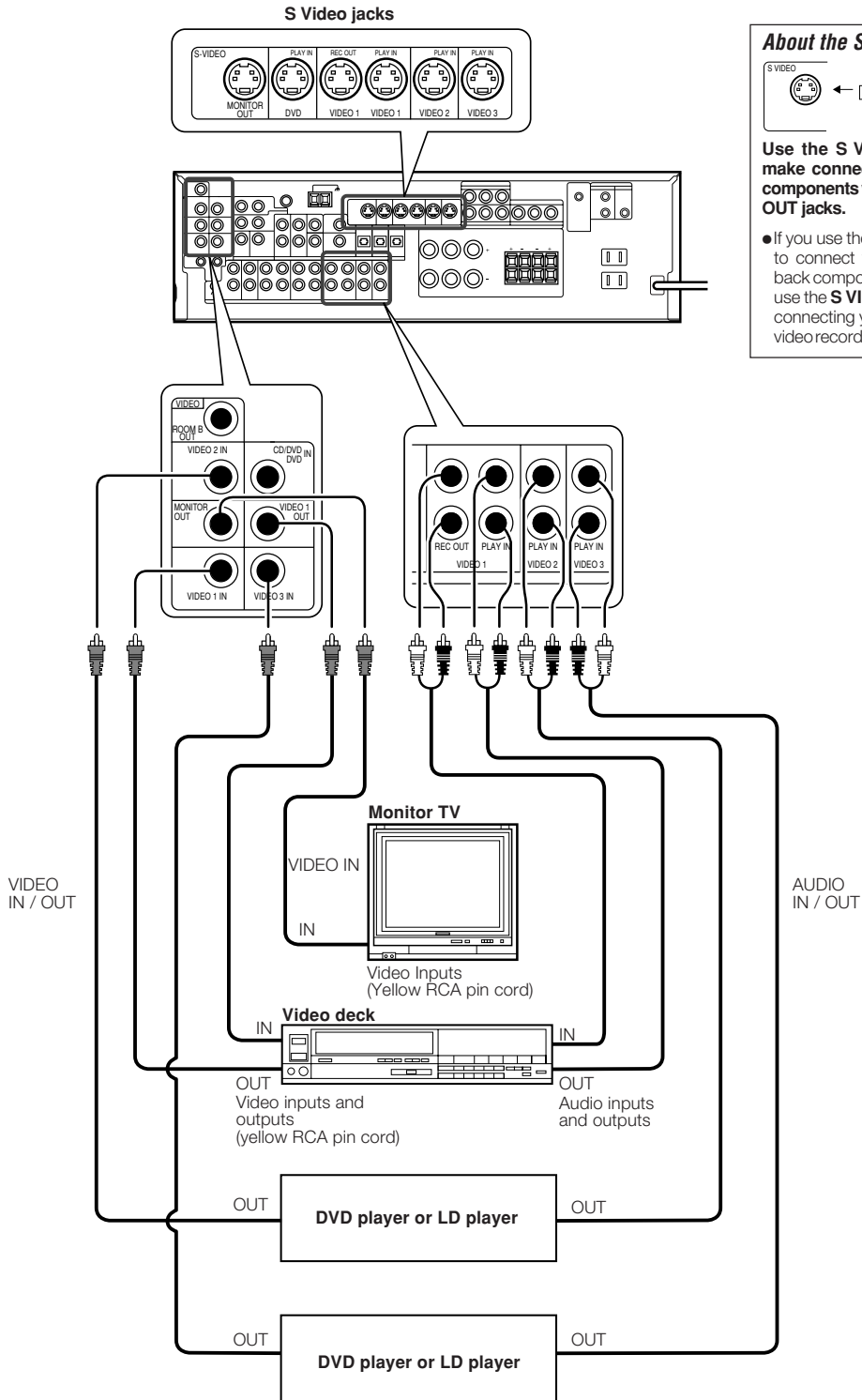

A video component with digital audio outputs should be connected to the VIDEO2 or VIDEO3 jacks.

## Digital connections

The digital in jacks can accept DTS, Dolby Digital, or PCM signals. Connect components capable of outputting DTS, Dolby Digital, or standard PCM (CD) format digital signals. If you have connected any digital components to the receiver, be sure to read the "Input mode settings" section carefully. 

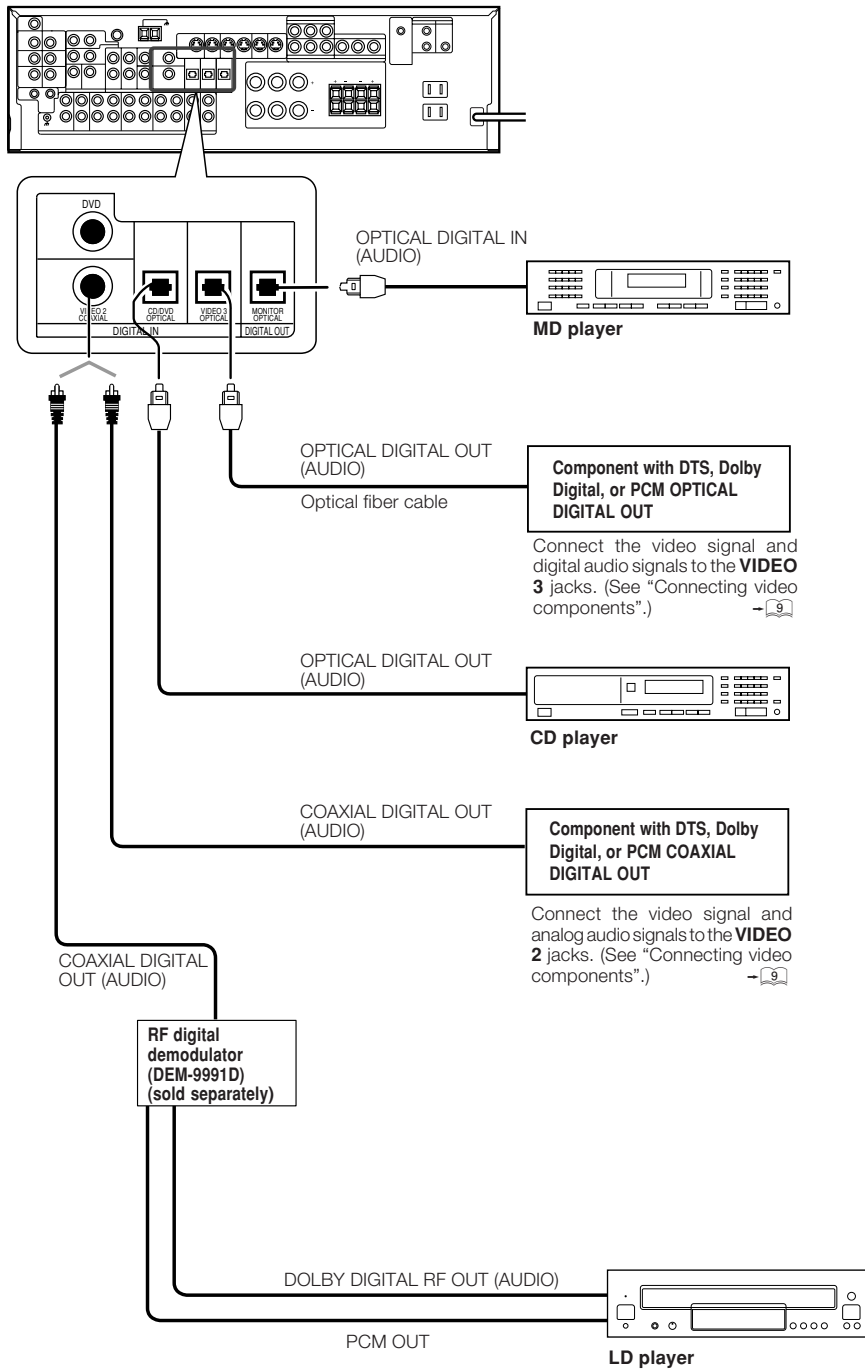

To connect an LD player with a DIGITAL RF OUT, connect the LD player to the KENWOOD RF digital demodulator (DEM-9991D). Next, connect the DIGITAL OUT jacks of the demodulator to the DIGITAL IN jacks of the receiver. Connect the video signal and analog audio signals to the VIDEO 2 or VIDEO 3 jacks. (See "Connecting video components".)

## Connecting video components (COMPONENT VIDEO)

If you have connected the receiver to a video component with COMPONENT jacks, you can get a better picture quality than by connecting to the S-VIDEO jacks.

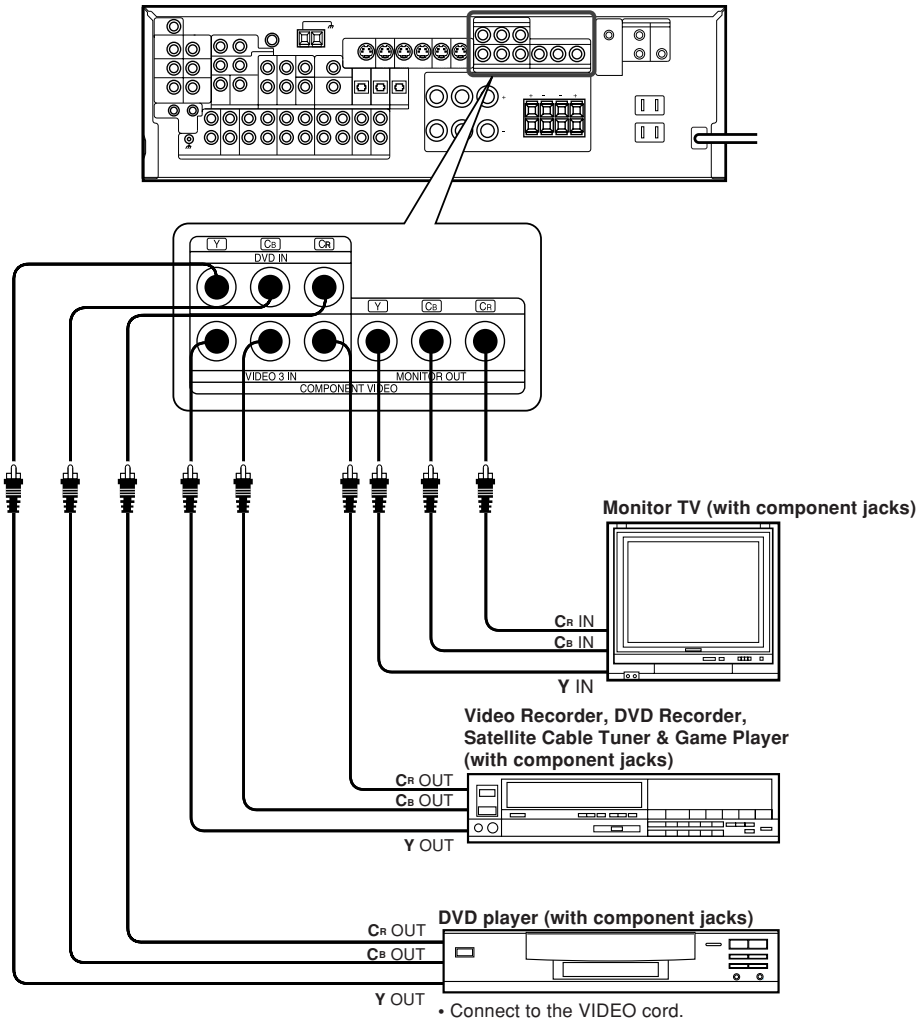

When connecting the TV to the COMPONENT jacks, be sure to connect all the other components to the COMPONENT jacks.

### Connecting a DVD player (6-channel input)

If you have connected a DVD player to the receiver with digital connection, be sure to read the "Input mode settings" section carefully. 

Preparations

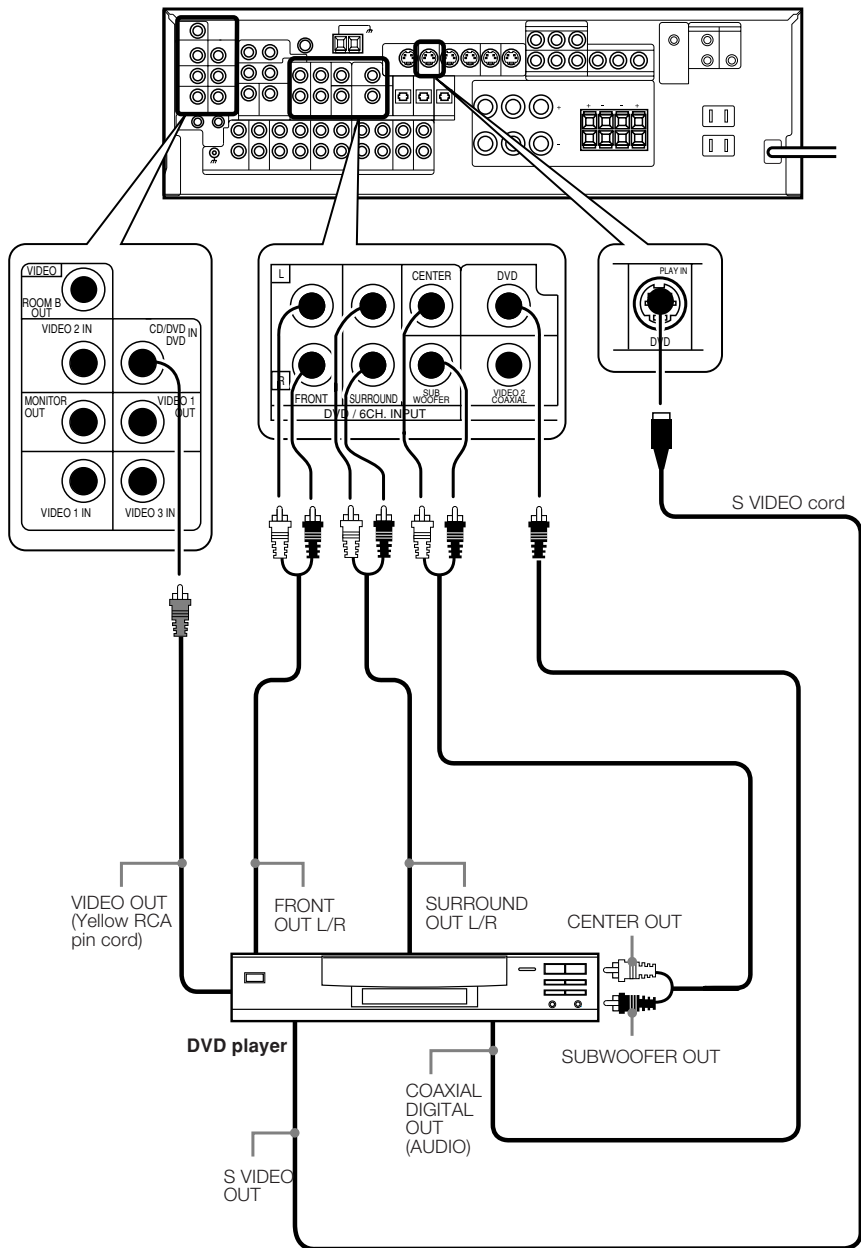

To switch the speakers off , turn SPEAKERS A and B OFF or press MUTE key on the remote control unit.

# Connecting the speakers

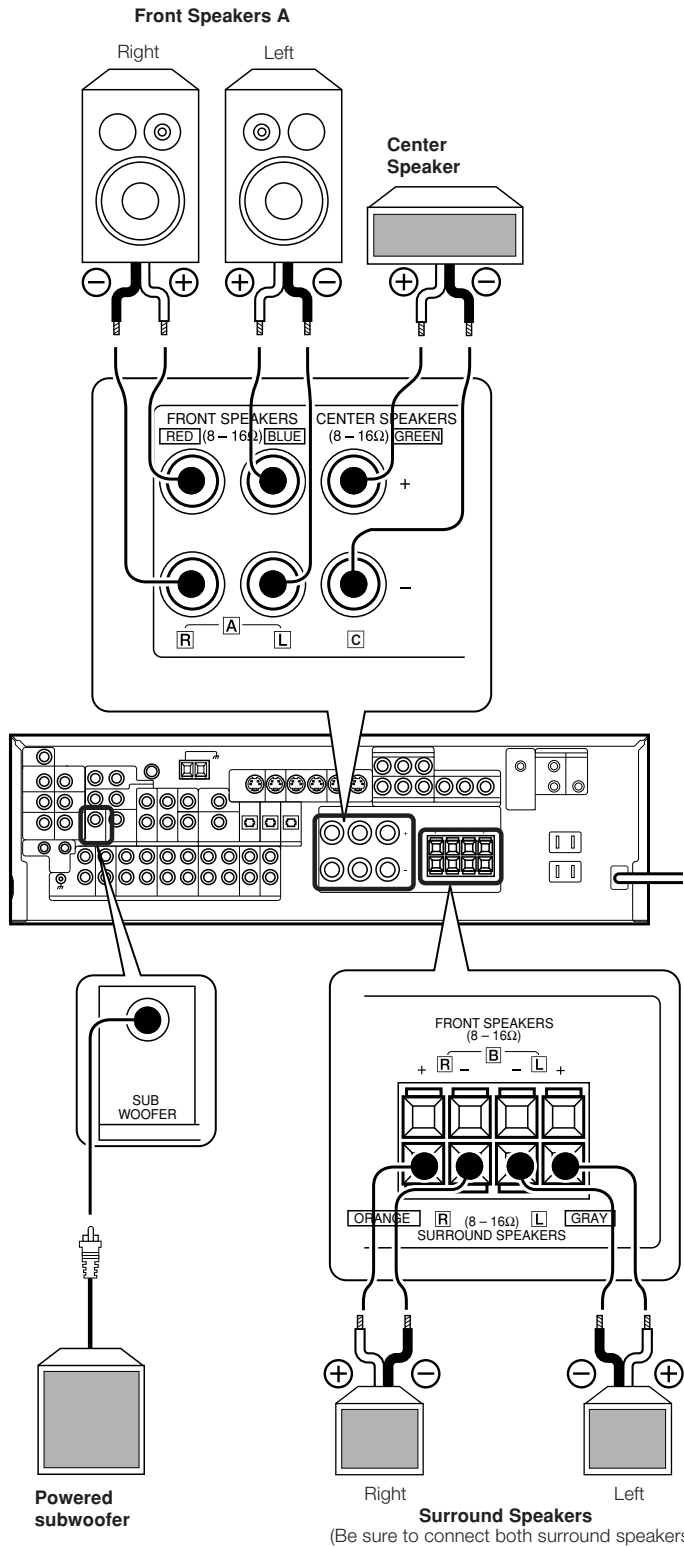

## Connecting the terminals

**1 Strip coating.** **2 Loosen.**



**3 Insert.** **4 Secure.**



**1 Strip coating.** **2 Push the lever.**



**3 Insert the cord.** **4 Return the lever.**

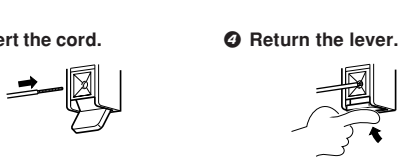

**Connection of banana plugs**

**1 Secure.** **2 Insert.**

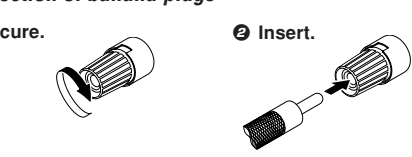

- Sound will not be heard if the speaker terminal is not fully secured.

- Never short circuit the + and – speaker cords.
- If the left and right speakers are connected inversely or the speaker cords are connected with reversed polarity, the sound will be unnatural with ambiguous acoustic imaging. Be sure to connect the speakers correctly.

### Speaker impedance

After confirming the speaker impedance indications printed on the rear panel of the receiver, connect speakers with matching impedance ratings. Using speakers with a rated impedance other than that indicated on the rear panel of the receiver could result in malfunctions or damage to the speakers or receiver.

### Speaker placement

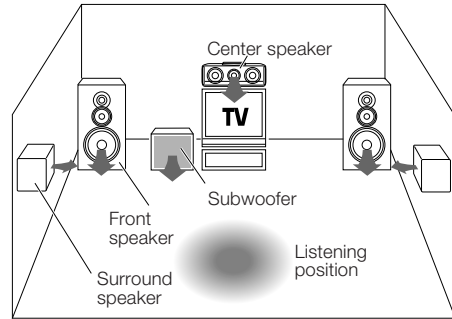

**Front speakers :** Place to the front left and right of the listening position. Front speakers are required for all surround modes.

**Center speaker :** Place front and center. This speaker stabilizes the sound image and helps recreate sound motion. Be sure to connect a center speaker when using the Dolby 3 Stereo mode.

**Surround speakers :** Place to the direct left and right, or slightly behind, the listening position at even heights, approximately 1 meter above the ears of the listeners. These speakers recreate sound motion and atmosphere. Required for surround playback.

**Subwoofer :** Reproduces powerful deep bass sounds.

- Although the ideal surround system consists of all the speakers listed above, if you don't have a center speaker or a subwoofer, you can divide those signals between the available speakers in the speaker settings steps to obtain the best possible surround reproduction from the speakers you have available. - 22

## Connecting to another room (ROOM B)

This connection allows you to connect your main system to a monitor TV and speaker system located in another area (ROOM B).

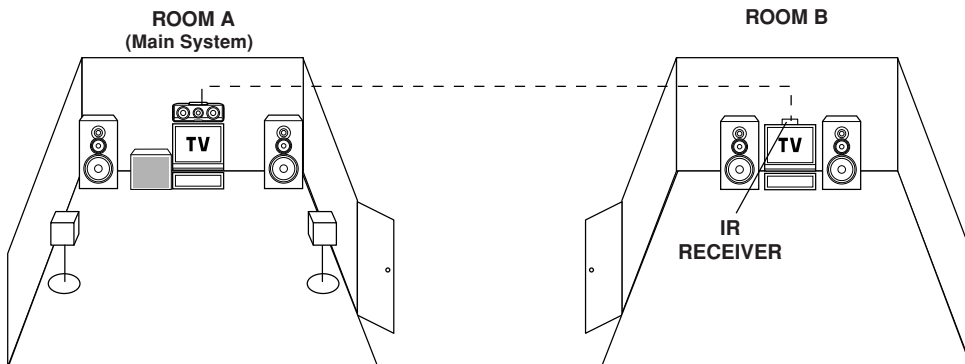
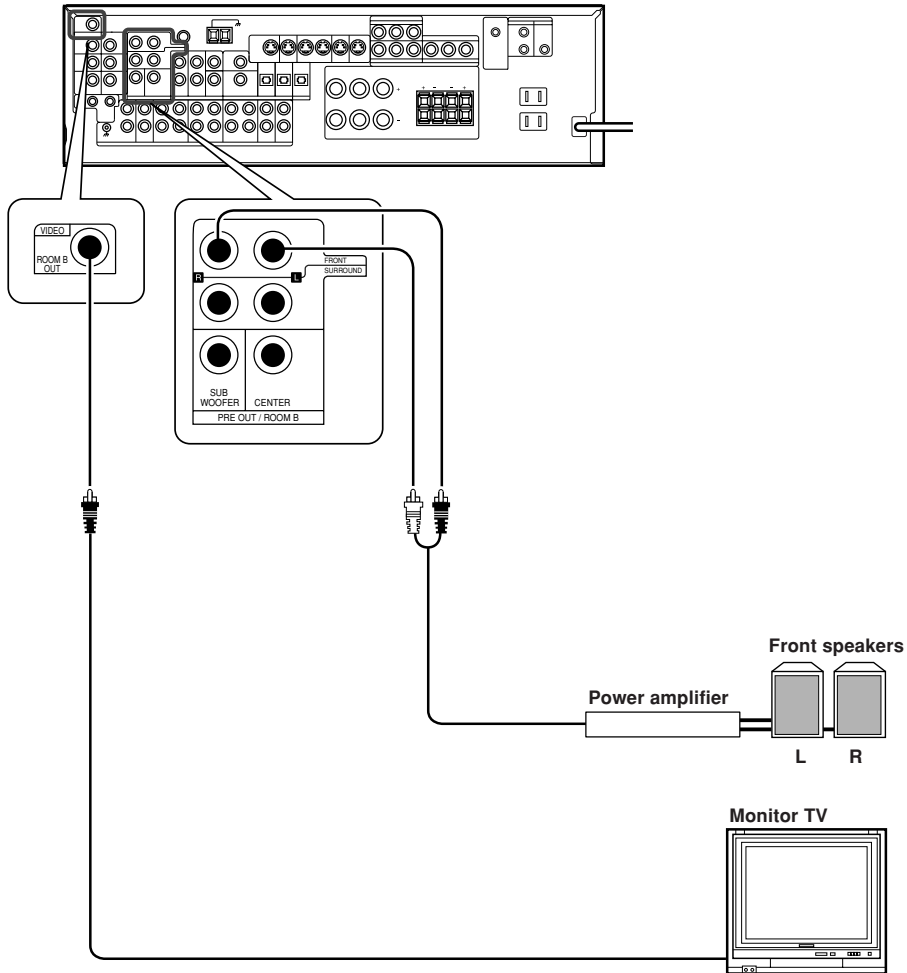

## PRE OUT connections

16

This receiver has additional preout jacks. These can be used for various purposes, but will need to be connected to an external power amplifier as shown in the example below.

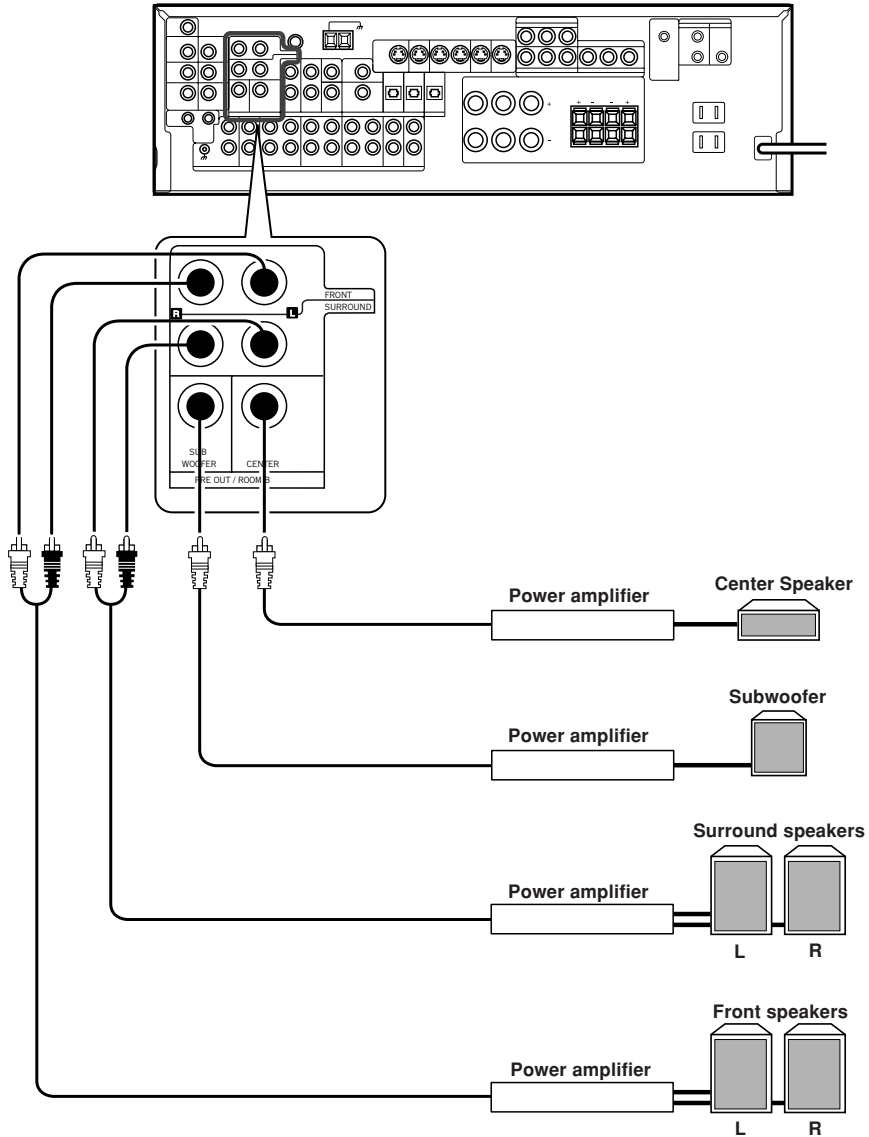

- Connecting a speaker cord directly to a **PRE OUT** jack will not produce any sound from the speaker.
- To use the **PRE OUT** jacks, press only the **SPEAKERS A** key to the ON position.
- This connection is available for listening in ROOM B.



## Connecting the RF antenna, external IR Receiver and external IR Repeater

The remote control for this receiver has the RF (radio frequency) and IR (infrared rays) transmission function. It enables you to control the receiver not only by aiming at the receiver but also by aiming at the RF antenna as well as the external IR receiver. In addition, you can enjoy a wider remote control signal range by placing the RF antenna and IR receiver away from the receiver.

**KENWOOD components (except DVD player) : System control** - 20  
**Other components: (Registering setup codes) IR REPEATER** - 36

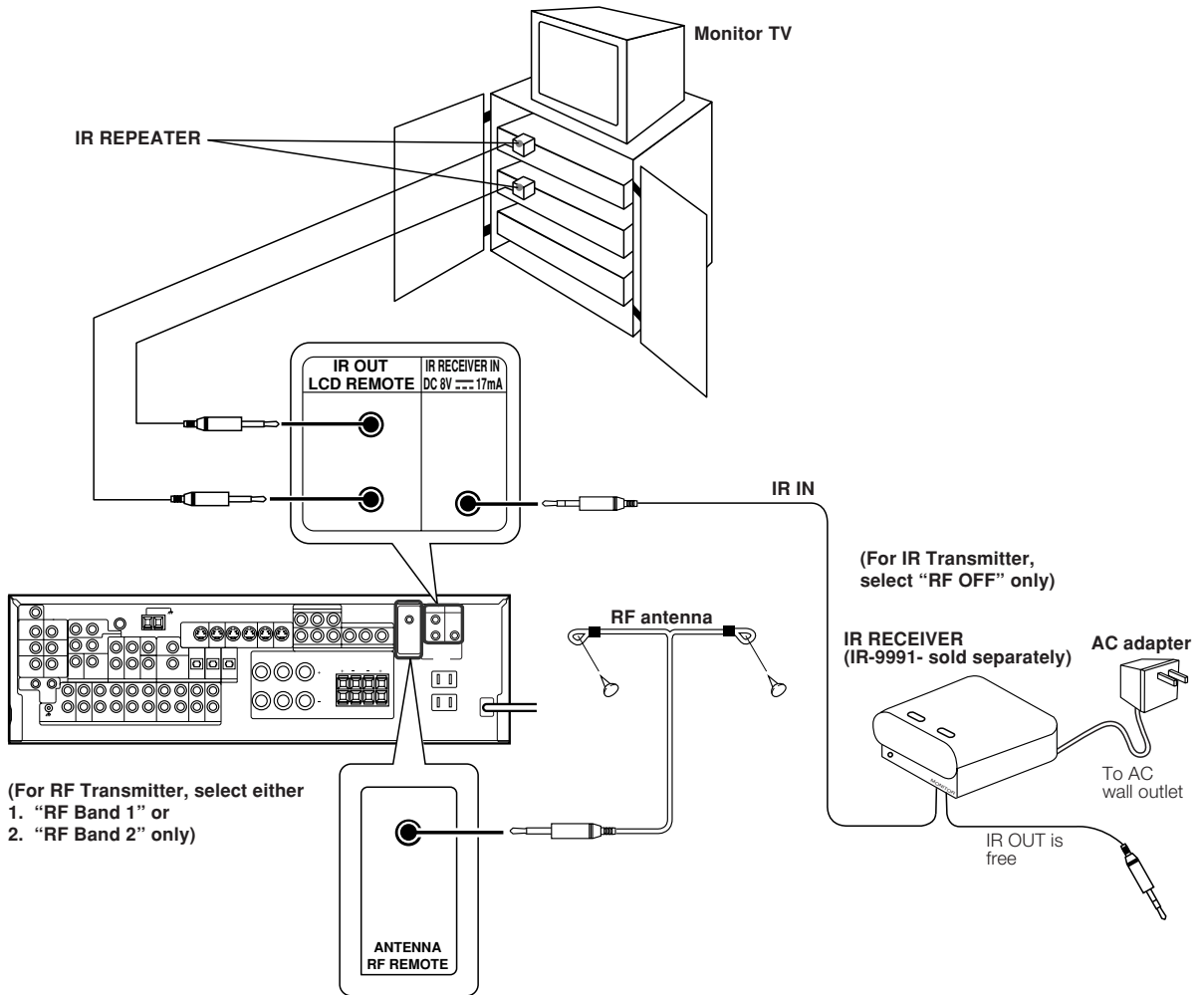

(For RF Transmitter, select either  
 1. "RF Band 1" or  
 2. "RF Band 2" only)

(For IR Transmitter,  
 select "RF OFF" only)

Shape of plug to be connected.

	IR Receiver IN	IR OUT LCD Remote
	Stereo mini plug	Mono mini plug
	Sleeve	Sleeve
	Tip	Tip
	Ring	
<b>IR IN / OUT SPECIFICATION:</b>		
Terminal	IR Receiver IN	IR OUT LCD Remote
To Tip	Signal	Signal
To Ring	Ground	
To Sleeve	+ 8V	Ground

## Connecting to the AV AUX jacks

The **AV AUX** jacks are convenient for connection of video components such as a camcorder or a video game.

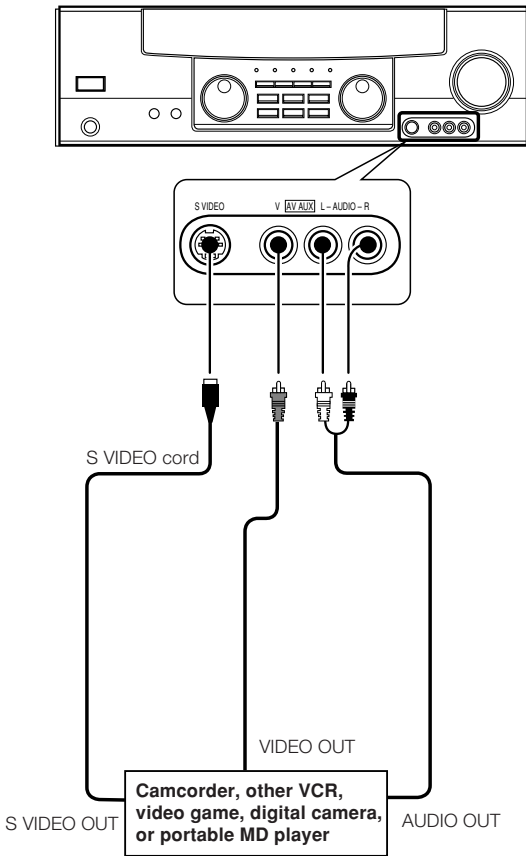

## Connecting the antennas

### AM loop antenna

The supplied loop antenna is for use indoors. Place it as far as possible from the receiver, TV set, speaker cords and power cord, and adjust the direction for best reception.

#### AM antenna terminal connections

① Push lever.

② Insert cord.

③ Release lever.

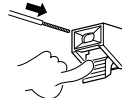
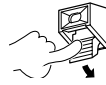

### FM indoor antenna

The supplied indoor antenna is for temporary use only. For stable signal reception we recommend using an outdoor antenna. Disconnect the indoor antenna when you connect one outdoors.

#### FM antenna terminal connections

Insert cord.



### FM outdoor antenna

Lead the 75Ω coaxial cable connected to the FM outdoor antenna into the room and connect it to the **FM 75Ω** terminal.

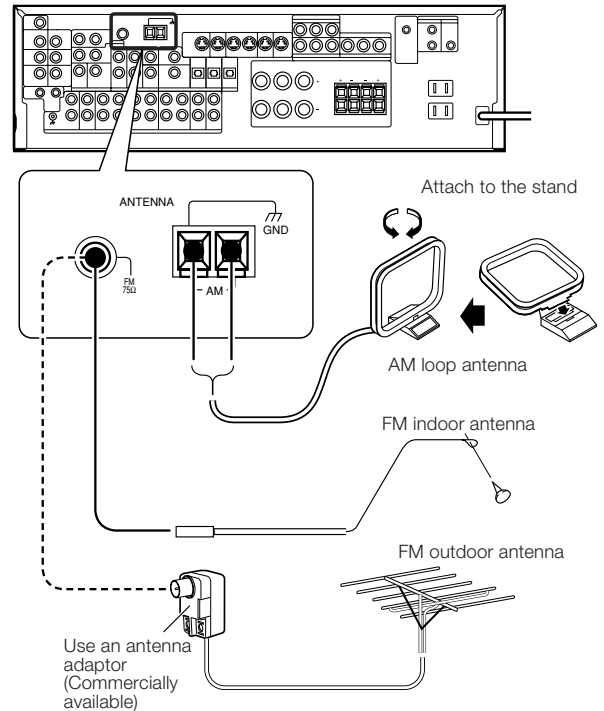

- To select the source connected to the AV AUX jacks, select AV AUX by using the INPUT SELECTOR knob. — 24
- When you connect the audio source such as the MD player, you do not need to connect the video cable.
- When you connect the unit and the component with the S VIDEO cord, you can get better picture quality.

## RF remote control function

The remote control has the RF remote function in addition to the IR remote function. The VR-510 can receive the remote control commands even when they are installed in a position where the IR remote signal can hardly access, for example inside a cabinet. The receiver is not equipped with the RF remote bi-directional communication function. The bi-directional communication is available only using the IR remote function.

### Changing the RF transmission frequency

The RF remote function may be unavailable due to radio wave cross talk, etc. In this case, the transmission frequency can be changed.

To change the RF remote transmission frequency:

- 1 Open the battery cover on the rear.

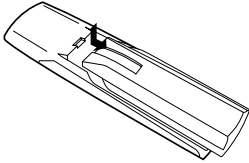

- 2 Change the RF switch setting.

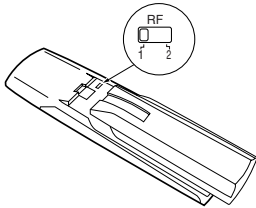

After changing the RF frequency of remote control, be also sure to change that of the receiver.

- 3 Change the receiver's RF reception frequency.

- Press and hold the **SET UP** key on the front panel of the receiver for more than 2 seconds. Each time you press the **SET UP** key, the RF reception frequency changes as follows:

- 1 "RF BAND 1"
- 2 "RF BAND 2"
- 3 "RF OFF"

- Select the same number as the position number of the RF switch of the remote control.

### Loading the batteries

- 1 Remove the cover.
- 2 Insert the batteries.

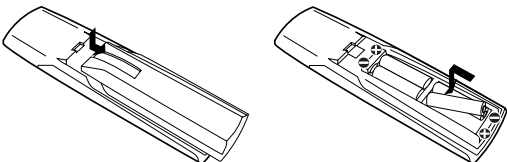

- 3 Close the cover.

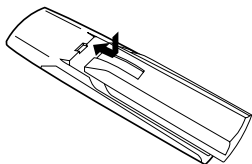

- Insert four AA-size (R6) batteries as indicated by the polarity markings.

### Remote control operation

When the **STANDBY** indicator is lit, the power turns ON when you press the **SYS. POWER** I/⏻ key on the remote control. When the power comes ON, press the key you want to operate.

#### Operating receiver range (RF Transmitter)

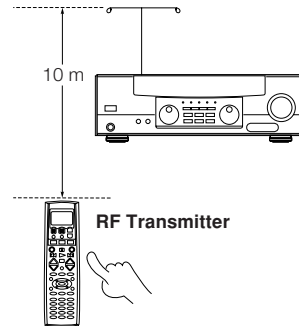

#### Operating other component range (IR Transmitter)

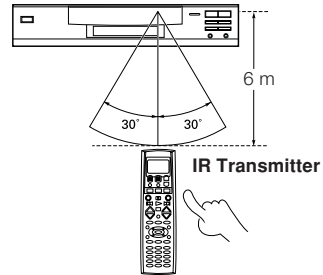

- The remote control signal received by the main unit are IR and RF signals.
- When pressing more than one remote control key successively, press the keys securely by leaving an interval of 1 second or more between keys.

#### Notes

1. The supplied batteries may have shorter lives than ordinary batteries due to use during operation checks.
2. When the remote-controllable distance gets shorter than before, replace all batteries with a new ones.
3. Placing the remote sensor in direct sunlight, or in direct light from a high frequency fluorescent lamp may cause a malfunction. In such a case, change the location of the system installation to prevent malfunction.

#### Important notes

Here is list of adjustment which can maximize the operation of your remote control. For optimal operation of the remote control:

- 1 Aim the remote control toward the room where the receiver is located.
- 2 Do not position the receiver and remote control near metal (such as heat ducts). Metal can absorb RF signals.
- 3 Make sure the batteries in the remote control are fully charged. Weak batteries will affect the range of the remote control.
- 4 When there is an obstruction around other equipments that send signal from the remote control, the control distance of the RF remote signal will be short.

#### Note

- The tests for range limits of the remote control and the receiver are conducted in open-air distance test. Actual distance of the signal will be based on the construction of the building the unit is being used in as well as other factors such as outside interference.

## Connecting the system control

Connecting system control cords after connecting a KENWOOD audio component system lets you take advantage of convenient system control operations.

This unit is compatible only with the [SL16] mode. The system control operation is not available if the unit is connected in the [XS8], [XS], or [XR] connection mode.

If your component has the mode select switch, set the connected components to the [SL16] mode.

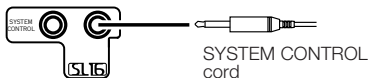

- You may connect the system control cord to either the left or right jack.

### EXAMPLE: [SL16] mode connections

The underlined portion represents the setting of the system control mode.

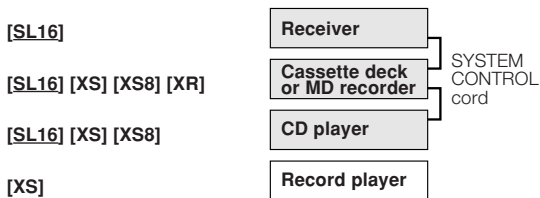

- In order to take advantage of the system control operations, the components must be connected to the correct jacks. To use a CD player it must be connected to the CD jacks. To use a cassette deck (or MD recorder) it must be connected to the MD/TAPE jacks. When using more than one CD player (etc.) only the one connected to the specified jacks may be connected for system control.
- Some CD players and cassette decks are not compatible with the [SL16] system control mode. Do not make system connections with equipment that is not [SL16] compatible.
- Some MD players are not system control compatible. You cannot make system control connections to this kind of equipment.

#### Notes

- [SL16] equipment cannot be combined with [XR], [XS], and [XS8] equipment for system operations. If your equipment consists of this kind of combination, please do not connect any system control cords. Even without system control cords, normal operations can be carried out without effecting performance.
- Do not connect system control cords to any components other than those specified by KENWOOD. It may cause a malfunction and damage your equipment.
- Be sure the system control plugs are inserted all the way in to the system control terminals.

### SYSTEM CONTROL OPERATIONS

#### Remote Control

Lets you operate this unit with the system remote supplied with the receiver.

#### Automatic Operation

When you start playback from a source component, the input selector on this unit switches to that component automatically.

#### Synchronized Recording

Lets you synchronize recording with the start of playback when recording from CD, MD or analog discs.

### Registering setup codes for KENWOOD audio components

- If you own remote controllable KENWOOD audio components that are not compatible with system control, registering the setup code enables you to control those components using the remote control supplied with this unit (without connecting system control cords). To register setup codes for your remote controllable KENWOOD audio components, see "Registering setup codes for other components".

**Do not connect a system control cord to a cassette deck connected to the MONITOR jacks.**

The remote control sends an RF (radio wave) signal to the receiver. For equipment other than the receiver, an IR (Infrared) signal is sent.

The remote control supplied with this receiver is also capable of controlling components from a variety of manufacturers once you register the appropriate setup codes into the remote control unit. Refer to "Remote control operation of other components" for details about the operations available for each component. - 43

## How to use the display operation keys

To register the setup code, use the **display operation 1** key, **display operation 2** key, or **▲/▼** keys.

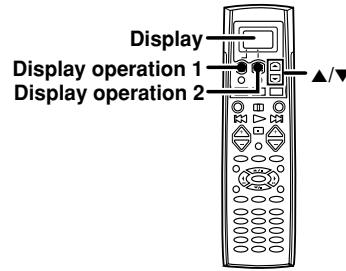

The **display operation 1** key and **display operation 2** key work as the function key displayed in the display above.

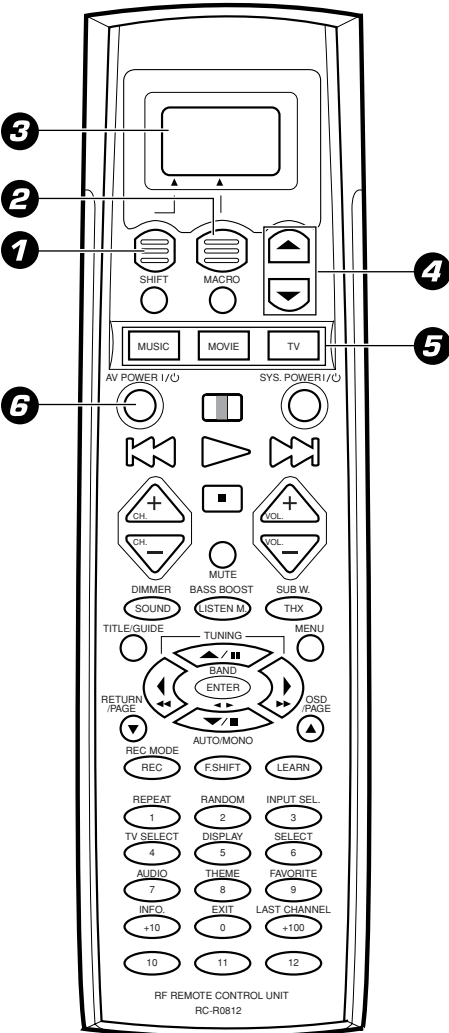

### The display operation 1 key

- **[Back]**  
Go back to the previous display.
- **[Home]**  
Go back to the initial display.
- **[Clr]**  
Erase the internal memory.

### The display operation 2 key

- **[Enter]**  
Enter the selected item.
- **[Menu]**  
Display the menu.
- **[Setup]**  
Go to the setup display.
- **[Exit]**  
Exit from the current operation.
- **[Sel]**  
Select the item.

### When the display goes off

The display goes off automatically when you do not operate for more than 8 seconds. In this case, press the **display operation 1** key, **display operation 2** key, or **▲/▼** keys.

### When you are confused about what's being displayed

Press the **display operation 1** key repeatedly until "Menu" appears in the display. The display returns to the initial display.

- 1 Display operation 1 key**  
Use this key to go back to the previous display or initial display.
- 2 Display operation 2 key**  
Gets you into and out of the preset code registration mode.
- 3 Display**  
The information for setup is displayed.
- 4 ▲/▼ keys**  
Use these keys to select the source or setup code.
- 5 MOVIE, MUSIC, and TV keys**  
Use these keys to select the input you want to register.
- 6 AV POWER I/O key**  
Once you have entered the setup code for another component, you can press this key to turn power to that component on or off. This lets you confirm that you entered the code properly.

## Speaker settings

To enable you to obtain optimum enjoyment from the receiver's listening modes, make sure to complete the speaker settings (subwoofer, front, center, and surround speakers) as described below.

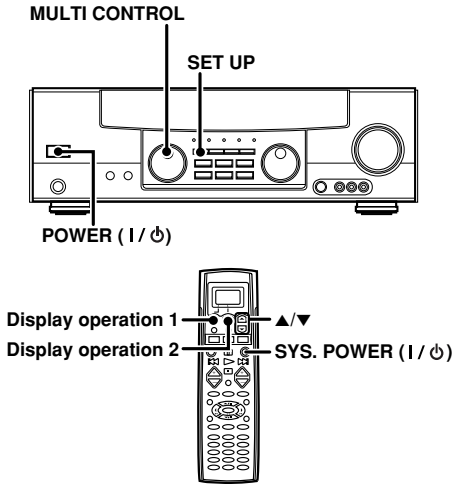

**1** Turn on the power to this receiver by pressing **POWER (I/O)** or **SYS. POWER (I/O)** key.

**2** Select a speaker system.

① Press the **SET UP** key such that the subwoofer setting indication **SUBWOOFER** scrolls across the display.



Blinks

When you operate on the remote control unit

① Press the **display operation 2 [Menu]** key repeatedly until "01. IR" appears in the display of the remote control unit.

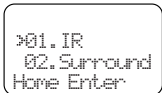

② Press the **▲/▼** keys to select "02. Surround", then press the **display operation 2 [Enter]** key.

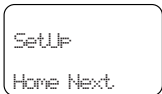

③ Use the **MULTI CONTROL knob** or **▲/▼** keys to select the appropriate subwoofer setting.

- ① **ON** : Subwoofer setting mode to the receiver is ON.
- ② **OFF** : Subwoofer setting mode to the receiver is OFF.

- The initial setting is "SUBWOOFER ON".
- When "SUBWOOFER OFF" is selected, the front speakers are automatically set to "LRG" and the procedure skips to step ⑤.
- When subwoofer output sound is required, select "FRONT NML".

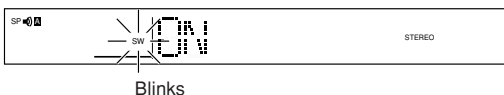

Blinks

④ Press the **SET UP** or **display operation 2 [Next]** key to accept the setting.

- The front speakers setting indication "FRONT" scrolls across the display

⑤ Use the **MULTI CONTROL knob** or **▲/▼** keys to select the appropriate front speakers setting.

- ① **NML/THX (normal)** : Average size front speakers are connected to the receiver.
- ② **LRG (large)** : Large front speakers are connected to the receiver.

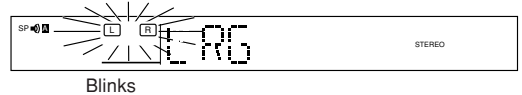

Blinks

- Under certain circumstances, for "FRONT LRG" selection, no sound will be heard from the subwoofer even when it is set to ON. However, if you select SW RE-MIX ON when subwoofer is selected, you may hear sound from the subwoofer.

⑥ Press the **SET UP** or **display operation 2 [Next]** key to accept the setting.

- The center speaker setting indication "CENTER" scrolls across the display.

⑦ Use the **MULTI CONTROL knob** or **▲/▼** keys to select the appropriate center speaker setting.

- If you have selected "LRG" as the front speakers setting,
- ① **NML/THX (normal)** : An average size center speaker is connected to the receiver.
  - ② **LRG (large)** : A large center speaker is connected to the receiver.
  - ③ **OFF** : Center speaker setting mode to the receiver is OFF.

If you have selected "NML" as the front speakers setting,

- ① **NML/THX** : Center speaker setting mode to the receiver is ON.
- ② **OFF** : Center speaker setting mode to the receiver is OFF.

⑧ Press the **SET UP** or **display operation 2 [Next]** key to accept the setting.

- The surround speaker setting indication "SURROUND" scrolls across the display.

⑨ Use the **MULTI CONTROL knob** or **▲/▼** keys to select the appropriate surround speaker setting.

- If you have selected "LRG" as the center speaker setting,
- ① **NML/THX (normal)** : Average size surround speakers are connected to the receiver.
  - ② **LRG (large)** : Large surround speakers are connected to the receiver.
  - ③ **OFF** : Surround speaker setting mode to the receiver is OFF.

If you have selected other than "LRG" as the center speaker setting,

- ① **NML/THX** : Surround speaker setting mode to the receiver is ON.
- ② **OFF** : Surround speaker setting mode to the receiver is OFF.

⑩ Press the **SET UP** or **display operation 2 [Next]** key to accept the setting.

- The subwoofer remix setting indication "SW RE-MIX" scrolls across the display.

**3** Select the subwoofer re-mix setting.

① Use the **MULTI CONTROL knob** or **▲/▼** keys to select the appropriate subwoofer remix setting.

- ① **ON** : Subwoofer re-mix set mode to the receiver is ON.
- ② **OFF** : Subwoofer re-mix set mode to the receiver is OFF. This is the THX preferred setting.

“SW RE-MIX” scrolls across the display



2 Press the SET UP or display operation 2 [Next] key to accept the setting.

- The receiver enters the speaker volume level adjustment mode.
- In step 2, indications appear only for the selected channels of the speakers that require adjusting.

4 Adjust the speaker volume.

From your usual listening position, adjust the volume levels. The volume levels from each speaker should be the same.

1 Use the MULTI CONTROL knob or ▲/▼ keys to adjust the volume of the test tone output from the speaker channel to be adjusted.

The channel indication blinks while the test tone is being output.

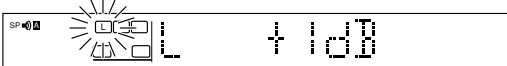

The test tone is heard from the speakers in the following sequence for 2 seconds each:

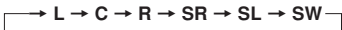

- If you change the volume level settings for the speakers while listening to music, the settings referred to on this page are also changed.
- If the speaker setting selects are OFF, the speaker level settings are reset.

2 Press the SET UP or display operation 2 [Next] key.

- The test tone is turned off. The receiver enters the mode for inputting the bass peak level and the current peak level will be shown.
- To obtain accurate output levels, it is recommended to use a handheld Sound Pressure Level (SPL) meter. Readings should be taken from your actual listening position and adjust the level of each speaker to 75dB SPL (C-weighted/slow meter mode).

5 Adjust the bass peak level.

A restriction is put on the low frequency so that the bass peak level will not go higher than the acceptable level when the volume is increased.

If subwoofer speaker is OFF, the limitation will affect the low frequency of the front left and right speakers.



1 Use the MULTI CONTROL knob or ▲/▼ keys to adjust the bass peak level to -30.

- The bass peak level may be adjusted from -30dB to 0dB and OFF.
- When no subwoofer is in use, the test tone will be output from the front channel speakers.

2 To find the bass peak level limit, keep increasing the bass peak level by using the MULTI CONTROL knob or ▲/▼ keys while test tone is being output until the clip point of the subwoofer is found.



3 Press the SET UP or display operation 2 [Next] key.

- The receiver enters the mode for inputting the distance to the speakers.

6 Input the distance to the speakers.

1 Measure the distance from the listening position to each of the speakers.

Not down the distance to each of the speakers.

- Distance to front left speaker : \_\_\_ feet (meters)
- Distance to center speaker : \_\_\_ feet (meters)
- Distance to front right speaker : \_\_\_ feet (meters)
- Distance to surround right speaker : \_\_\_ feet (meters)
- Distance to surround left speaker : \_\_\_ feet (meters)
- Distance to subwoofer : \_\_\_ feet (meters)

2 Use the MULTI CONTROL knob or ▲/▼ keys to select the distance to the front speakers.

The speaker indicator to be adjusted blinks.



Indication in feet Indication in meters

- The allowable setting range is 1 to 30 feet (0.3 to 9.0m), adjustable in 1 foot (0.3 m) increment.

3 Press the SET UP or display operation 2 [Next] key.

4 Repeat steps 2 and 3 to input the distance for each of the speakers.

5 Setup is complete when the input indication reappears.

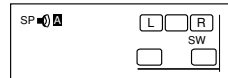

Display when all speakers have been selected.

- The speakers you have selected should appear on the display. Confirm that all the speakers have been correctly selected.

Input level adjustment (analog sources only)

If the input level of an analog source signal is too high, the CLIP indicator will blink. Adjust the input level.

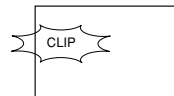

1 Use the INPUT SELECTOR knob to select the source which you want to adjust.

- You can store a separate input level for each input source. If the MONITOR function is ON, you can store an input level for when MONITOR is on independently of the input levels for the input sources.

2 Press the SOUND key repeatedly until the “INPUT” indication appears.

3 Use the MULTI CONTROL knob or ▲/▼ keys to adjust the input level.



- The adjustment mode is displayed for approximately eight seconds.
- The input level may be adjusted to any one of three settings: 0dB, -3dB, and -6dB. (The initial setting is 0dB.)

4 Press the SOUND key again to return to the input indication.

# Normal playback

## Preparing for playback

Some preparatory steps are needed before starting playback.

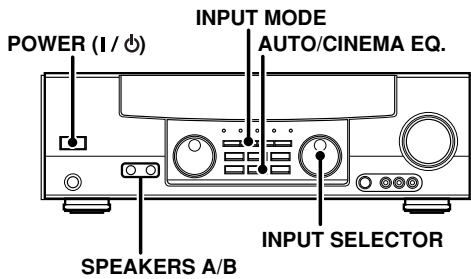

### Selecting the input mode

If you have selected a component connected to the **CD/DVD**, **DVD/6ch**, **VIDEO2**, or **VIDEO3** jacks, make sure that the input mode setting is correct for the type of audio signal to be used. → 7

### Selecting MD/TAPE

Select the source name corresponding to the component connected to the MD/TAPE jacks. The initial factory setting is "TAPE". To change the source to "MD", follow the steps below:

- 1 Use the **INPUT SELECTOR** knob to select "MD/TAPE".
- 2 Hold down the **AUTO** key for more than 2 seconds.
  - The source indication changes to "MD".
  - To return to the original indication, repeat procedure 2.

### Selecting the speaker system

Press the **SPEAKERS A** or **B** key to select the speaker system to be used.

- A ON** : Sound from the speakers connected to the **SPEAKERS A** terminals on the rear panel.
- B ON** : Sound from the speakers connected to the **SPEAKERS B** terminals on the rear panel. No sound will be heard from the subwoofer.
- A+B ON** : Sound from both the speakers connected to the **SPEAKERS A** and **B** terminals on the rear panel.
- A+B OFF** : No sound from the speakers. Use this setting when listening with headphones for stereo sound in all playback modes.

The indicator for the speakers you want to use should be lit.

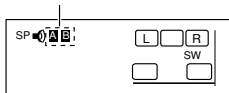

- Selecting "6ch INPT" by pressing the **INPUT MODE** key, whereby "DVD/6ch" is the input source will cause **SPEAKERS A** to be selected automatically.
- When you use the **PRE OUT** jacks, set only **SPEAKERS A** to ON mode.

### Turning on the receiver

- 1 Turn on the power to the related components.
- 2 Turn on the power to this receiver by pressing **POWER (I / O)** or **SYS. POWER (I / O)** key.

## Listening to a source component

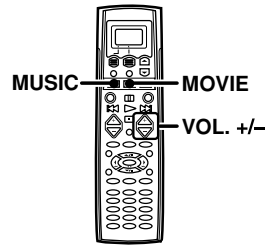
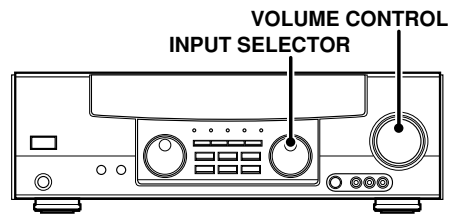

- 1 Use the **INPUT SELECTOR** knob, **MUSIC** key, or **MOVIE** key to select the source you want to listen to.

The input sources change as shown below:

Selecting a source using the **INPUT SELECTOR** knob

- 1 "PHONO"
- 2 "TUNER"
- 3 "CD/DVD"
- 4 "TAPE" or "MD"
- 5 "VIDEO1"
- 6 "VIDEO2"
- 7 "VIDEO3"
- 8 "DVD/6ch"
- 9 "AV AUX"

Selecting a source using the **MUSIC** key

- 1 "CD/DVD"
- 2 "TAPE" or "MD"
- 3 "TUNER"
- 4 "PHONO"

Selecting a source using the **MOVIE** key

- 1 "VIDEO1"
- 2 "VIDEO2"
- 3 "VIDEO3"
- 4 "DVD/6ch"
- 5 "AV AUX"

- MUSIC and MOVIE will not display input sources which are not pre-setup.

- 2 Start playback from the selected source.
- 3 Use the **VOLUME CONTROL** knob or **VOL. +/-** keys to adjust the volume.



## Adjusting the sound

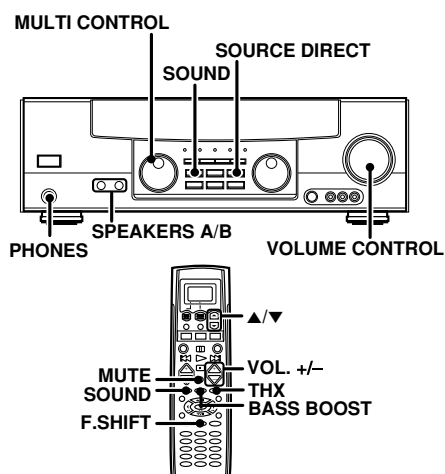

### Adjusting the tone

You can adjust the sound quality when the receiver is in the PCM stereo and analog stereo mode.

- Press the **SOUND** key repeatedly to select the tone mode to be adjusted.

**BASS:** Select this to adjust the low frequency range.  
(Press the **SOUND** key once.)

**TREB:** Select this to adjust the high frequency range.  
(Press the **SOUND** key twice.)

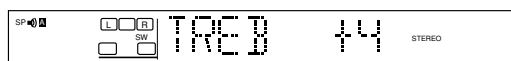

- Use the **MULTI CONTROL** knob or **▲/▼** keys to adjust the sound quality.

- The bass and treble levels are adjustable from -10dB to +10dB in 2 step increments.
- The adjustment item is displayed for approximately 8 seconds.
- BASS and TREB adjustment modes are not effective when THX is ON.

### Once-touch low frequency emphasis (bass boost) (Remote control only)

You can adjust the sound quality when the receiver is in the PCM stereo and analog stereo modes.

Press the **F.SHIFT** key, then press **BASS BOOST** key on the remote control.

- Press the key once to select the maximum (+10dB) low frequency emphasis setting.
- This key does not function when the receiver is in the sound quality or ambience effects adjustment mode.

### Switching back to the previous setting

Press the **BASS BOOST** key again.

- BASS BOOST** key is not effective when THX is ON.

### THX mode (Remote control only)

You may use the **THX** key to switch ON or OFF the THX mode. The initial factory setting for CD/DVD and DVD/6CH selectors is THX ON.

Each press switches the mode as follows:

- "THX ON"
- "THX OFF"

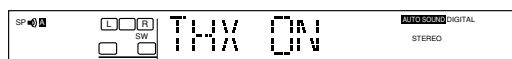

- When THX is ON, "THX" indicator lights up.

### Muting the sound

The **MUTE** key lets you mute the sound of the speakers.

Press the **MUTE** key.

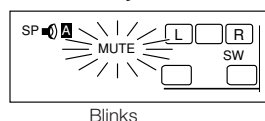

Blinks

**To cancel**

Press the **MUTE** key again so that the "MUTE" indicator goes off.

- MUTE ON** can also be deactivated by turning the volume control knob.

### SOURCE DIRECT playback (for analog sources only)

Use this function to pass the source material direct to the amplifier, bypassing any audio processing.

Press the **SOURCE DIRECT** key.

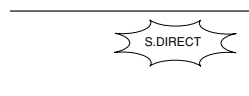

- When you press the **LISTEN MODE**, **SOUND**, or **SET UP** keys, or switch to another input source, **SOURCE DIRECT** playback will be canceled.

**To cancel**

Press the **SOURCE DIRECT** key again.

- If **SOURCE DIRECT** playback was activated when using a surround mode, canceling **SOURCE DIRECT** playback will reactivate the previous surround mode.

### Listening with headphones

- Press the **SPEAKERS A** and **B** key so that the speaker indicator goes off.

Make sure the **SPEAKERS** indicators are turned off.

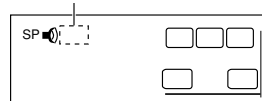

- If you turn off all of the speakers when in surround mode, the surround mode will be canceled as well, resulting in stereo playback.

- Connect the headphones to the **PHONES** jack.

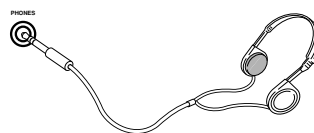

- Use the **VOLUME CONTROL** knob (**VOL. +/-** keys) to adjust the volume.

## Recording audio (analog sources)

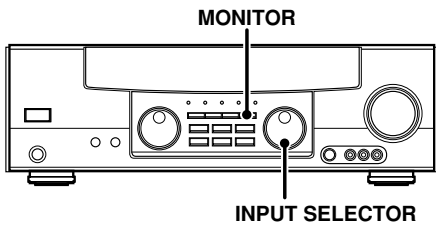

### Recording a music source

- 1 Use the **INPUT SELECTOR** knob to select the source (other than "MD/TAPE") you want to record.
- 2 Set the cassette deck or MD recorder to record.
- 3 Start playback, then start recording.

### Recording tapes or MD (with MONITOR function)

#### MONITOR → MD/TAPE recording

- 1 Press the **MONITOR** key.
- STEREO MONITOR
- 2 Use the **INPUT SELECTOR** knob to select a source other than "MD/TAPE".
  - 3 Start playback on the cassette deck connected to the **MONITOR** jacks and start recording on the cassette deck or MD recorder connected to the MD/TAPE jacks.

#### MD/TAPE → MONITOR recording

- 1 Use the **INPUT SELECTOR** knob to select "MD/TAPE".
- 2 Start playback on the cassette deck connected to the MD/TAPE jacks and start recording on the cassette deck connected to the **MONITOR** jacks.
  - To copy tapes using a double cassette deck, refer to the instruction manual of the double cassette deck.

### MONITOR function (analog sources only)

You can connect a cassette deck or graphic equalizer to the **MONITOR** jacks of the receiver. If a graphic equalizer is connected, the **MONITOR** key should be left in the on position. Alternately, if a cassette deck equipped with a 3-head system is connected to the **MONITOR** jacks, you will be able to monitor the just-recorded signal while making recordings on the cassette deck. By switching the **MONITOR** key on and off, you can compare the sound of the source signal and the just-recorded signal. For more information, refer to the instruction manual of the connected component.

## Recording video

- 1 Use the **INPUT SELECTOR** to select the video source (other than "VIDEO1") you want to record.
- 2 Set the video deck connected to **VIDEO 1** to record.
  - Select the REC MODE to record a digital input source.
- 3 Start playback, then start recording.
  - Recording may not be normal for some video software. This is due to the copy guard condition.

## Recording audio (digital sources)

Switch on the **REC** mode to record a digital input source. Usually use the **A-REC (Auto-Record)** mode to record audio input sources. When the digital mode changes during recording in the **A-REC** mode, the audio may be interrupted momentarily.

### Recording music in A-REC or M-REC mode

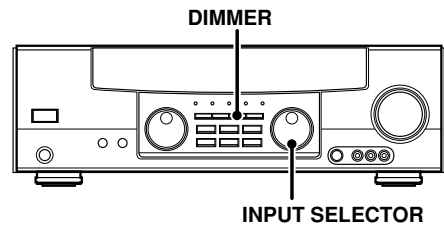

- 1 Use the **INPUT SELECTOR** knob to select the source (CD/DVD, DVD/6ch, VIDEO2, or VIDEO3) you want to record.
- 2 Set the cassette deck or MD recorder to record.
- 3 Press and hold the **DIMMER** key for more than 2 seconds to select the **A-REC** or **M-REC** mode.
  - The mode changes every 2 seconds as shown below.

- |  |   |
|--|---|
| <ol style="list-style-type: none"> <li>1 Rec mode off :</li> <li>2 A-REC :</li> <li>3 M-REC :</li> </ol> | <p>The digital input record mode is switched off.</p> <p>The digital input signals (DTS, Dolby Digital, or PCM) are identified automatically and converted into stereo signals that are ready for recording.</p> <p>The input signal type at the moment this mode is selected is held throughout this mode.</p> |
|--|---|

For **A-REC** mode:

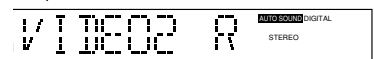

For **M-REC** mode:

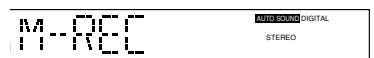

- 4 Play the source from the beginning and start recording.
  - If the audio reproduction stops in the middle due to change in the input signals, etc., press the **DIMMER** key.

# Listening to radio broadcasts

The receiver can store up to 40 stations in the memory and recall them by one-touch operation.

## Tuning radio stations

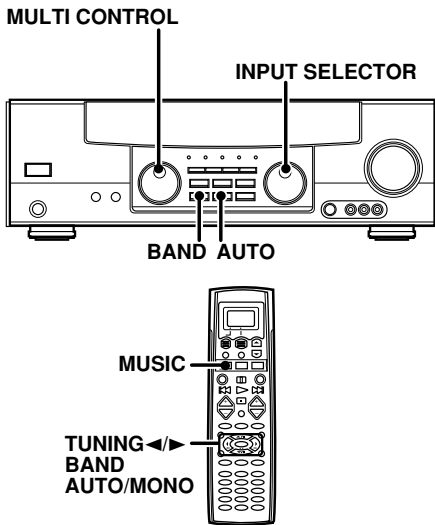

**1** Use the **INPUT SELECTOR** knob or **MUSIC** key to select the tuner.

**2** Use the **BAND** key to select the desired broadcast band.

Each press switches the band as follows:

- 1 FM
- 2 AM

"AM" or "FM" indicator appears in the display.

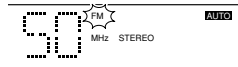

**3** Use the **AUTO/MONO** key to select the desired tuning method.

Each press switches the tuning method as follows:

- 1 AUTO lit (auto tuning)
- 2 AUTO not lit (manual tuning)

"AUTO" indicator lights up in the display.



• Normally, set to "AUTO" (auto tuning). If the radio waves are weak and there is a lot of interference, switch to manual tuning. (With manual tuning, stereo broadcasts will be received in monaural.)

**4** Use the **MULTI CONTROL** knob or **TUNING** ◀/▶ keys to select the station.

Frequency display "ST." lights up when a broadcast is being received in stereo.

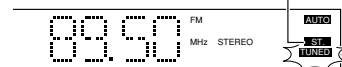

"TUNED" is displayed when a station is received.

**Auto tuning** : The next station is tuned automatically.

**Manual tuning** : Turn the knob (or press the keys) to select the desired station.

## Presetting radio stations manually

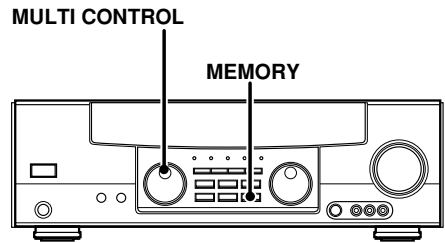

**1** Tune to the station you want to store.

**2** Press the **MEMORY** key while receiving the station.

Blinks for 5 seconds

Lights for 5 seconds

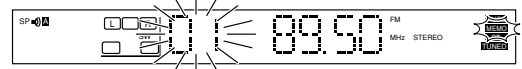

Proceed to step **3** within 5 seconds.

(If more than 5 seconds elapse, press the **MEMORY** key again).

**3** Use the **MULTI CONTROL** knob or **TUNING** ◀/▶ keys to select one of the station presets (1 – 40).

**4** Press the **MEMORY** key again to accept the setting.

- Repeat steps **1**, **2**, **3**, and **4** to store as many stations as necessary.
- If you store a station at a previously used preset, the old station will be replaced by the new one.

## Receiving preset stations

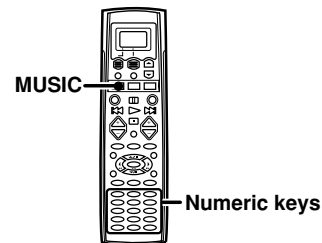

**1** Use the **MUSIC** key to select the tuner as the source.

**2** Enter the number of the preset you want to receive (up to "40").

Press the numeric keys in the following order:

For "15", press ..... [+10], [5]  
 For "20", press ..... [+10], [+10], [0]

- If you make a mistake entering a two digit number, press the **+10** key repeatedly to return to the original display and start again.



## Receiving preset stations in order (P.CALL)

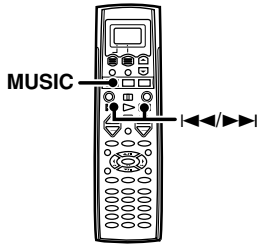

**1** Use the **MUSIC** key to select the tuner as the source.

**2** Use the **◀◀/▶▶** keys to select the desired station.

- Each time you press the key, another preset station is received in order.

Pressing the **▶▶** key does the following:

→ 01→02→03→ ...→ ... 38→39→40

Pressing the **◀◀** key does the following:

01←02←03← ...← ... 38←39←40←

Holding down the **▶▶** or **◀◀** key lets you skip through the presets, receiving each preset station at 0.5 second intervals.

# Ambience effects

This receiver is equipped with listening modes that allow you to enjoy an enhanced sonic ambience with a variety of video sources.

In order to obtain the optimum effect from the surround modes, make sure to input the proper speaker settings beforehand.

→ [22]

## Surround modes

### DTS

The DTS multi-channel audio format is available on CD, LD and DVD software. DTS is a strictly digital format and can not be decoded inside most CD, LD or DVD players. For this reason, if you attempt to listen to DTS encoded software through the analog output of your new CD, LD or DVD player, you will experience digital noise in most cases. This noise can be quite loud if the analog output is connected directly to a high power amplification system. Proper measures for playing the digital output as described below should be taken to avoid this situation. To enjoy DTS Digital Surround playback, an external 5.1 channel DTS Digital Surround decoder system or an amplifier with a built-in DTS Digital Surround decoder must be connected to the digital output (S/P DIF, AES/EBU or TosLink) of a CD, LD or DVD player.

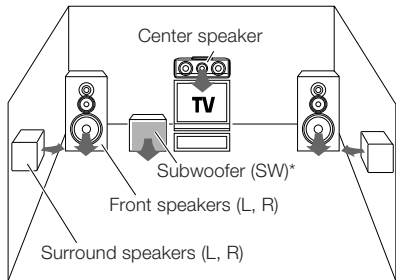

\* Optional in this mode.

\* LFE = Low Frequency Effects. This channel delivers separate non-directional bass signals to the subwoofer for more dynamic deep bass sound effects.

DTS has a .1 or LFE channel.

The indication "LFE" appears in the display when a signal is being input for this channel.

Manufactured under license from Digital Theater Systems, Inc. US Pat. No. 5,451,942 and other worldwide patents issued and pending.

"DTS" and "DTS Digital Surround" are trademarks of Digital Theater Systems, Inc.

© 1996 Digital Theater Systems, Inc. All rights reserved.



Manufactured under license from Dolby Laboratories. "Dolby", "Pro Logic" and the double-D symbol are trademarks of Dolby Laboratories. Confidential Unpublished Works. © 1992-1999 Dolby Laboratories, Inc. All rights reserved.

Circle Surround and the (C) symbol are trademarks of SRS Labs, Inc. in the United States and selected foreign countries. Circle Surround technology is incorporated under license from SRS Labs, Inc.

Lucasfilm and THX are registered trademarks of Lucasfilm Ltd.

### Dolby Digital

The Dolby Digital surround format lets you enjoy up to 5.1 channels of digital surround sound from Dolby Digital program sources (such as Laserdisc or DVD software marked ). Compared with previous Dolby surround, Dolby Digital provides even better sound quality, greater spatial accuracy, and improved dynamic range.

#### Note

Although a full set of speakers (front left, right, and center, surround left and right, and a subwoofer) is required for true 5.1 channel Dolby Digital surround sound, this receiver lets you enjoy Dolby Digital (and Dolby Surround) program sources, even if you connect only the front speakers.

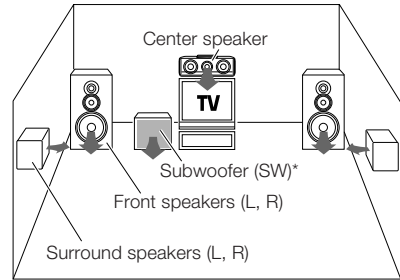

\* LFE = Low Frequency Effects. This channel delivers separate non-directional bass signals to the subwoofer for more dynamic deep bass sound effects.

Although only Dolby Digital soundtracks incorporate a separate low frequency channel, connecting a subwoofer will also improve deep bass performance in the other surround modes.

The indication "LFE" appears in the display when a signal is being input for this channel.

### Dolby Pro Logic II

Dolby Pro Logic II was designed specifically to provide a new sense of spatiality, directionality and articulation of sounds from Dolby Surround encoded sources (such as video and Laserdisc software marked ).

This is achieved with an intelligent, built-in feedback logic design, a matrix surround decoding and the decoding of stereo, full bandwidth surround outputs. The PRO LOGIC II modes programmed into this receiver are "MOVIE", "MUSIC" and "PRO LOGIC". The "MOVIE" mode of the PRO LOGIC II has preset characteristics to produce a calibrated, high-level surround sound playback while the MUSIC mode has user-adjustable characteristics to offer the three optical controls, like "Dimension", "Center Width" and "Panorama" modes to allow optimization of the soundfields as desired. The "Dimension" control allows the user to gradually adjust the soundfield either towards the front or towards the rear; the "Center Width" control allows various adjustment of the left-center-right speakers' balance; the "Panorama mode" extends the front stereo images to include the surround speakers for an exciting "wraparound" effect with side wall imaging.

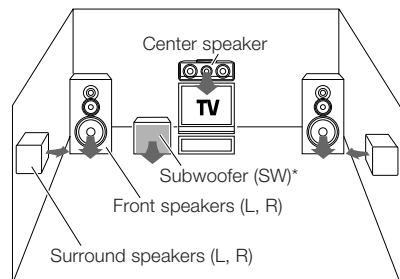

### Dolby 3 Stereo

Dolby 3 Stereo is available for systems that do not have surround speakers. When in the Dolby 3 Stereo mode, the surround information is redirected to the front left and right speakers. This mode is designed for use with Dolby Surround program sources, but can also improve sound field unity for programs that are not Dolby Surround encoded. Dialog positioning and sound image definition, however, may not be as accurate when used with programs that are not Dolby Surround encoded.

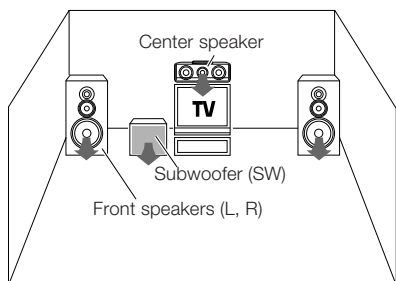

### Multi channel music (SRS Circle Surround)

SRS Circle surround enables you to listen to multi channel sound from the stereo source. We assume you have already enjoyed listening to Dolby digital sound/DTS multi channel sound with your multi speakers. Now, this time try listening to the stereo source (ex. Audio CD) using your multi speakers. You may discover a new type of "stereo" sound through SRS Circle Surround.

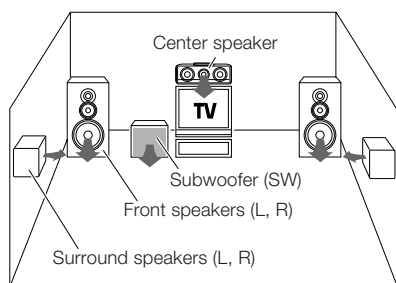

### Home THX cinema

THX is a creation of Lucasfilm Ltd., which practically brings the cinema sensation to your home with its superb multichannel digital audio program.

This system promises a reproduction of an enthralling home experience, which is able to encompass smaller space with fantastic audio output. In order to enjoy this function, an optimum speaker placement is required.

THX includes Re-equalization (Re-EQ), Timbre Matching, Adaptive Decorrelation, Bass Peak Level Manager and Loudspeaker Position Time Synchronisation.

#### Re-equalization (Re-EQ)

When listening in a typical home room, there may be some variation of echo due to air absorption and smaller space. The sound produced by flat response loudspeakers normally used in the cinema can be overly bright in the home environment. Thus, Re-equalization (Re-EQ) will adjust this condition to fit the home environment for a similar cinema effect.

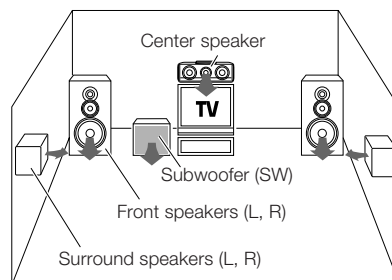

#### Timbre Matching

Due to human condition, listening to sound from various directions of speakers can be very disturbing. So, it is important to smoothen the flow of sound to suit the home cinema environment. Timbre Matching is able to smoothen the flow of sound to the listener who will be able to enjoy the cinema effect at home.

#### Adaptive Decorrelation

Mono sound track produced from the speaker system comes from only one direction, which does not exemplify the cinema surround sound experience. Adaptive Decorrelation is able to adjust the inaccuracy of this sound distribution.

#### Bass Peak Level Manager

Certain sound tracks may produced various bass peaks that could be unpleasant in a home cinema environment. Therefore, a user-adjustable Bass Peak Level Manager is used to control the bass level to suit the system's capacity.

#### Loudspeaker Position Time Synchronisation

This function enables you to adjust the different speaker's distance to your listening position. It permits an accurate synchronisation, which creates the ultimate sound environment.

**DSP mode**

The DSP mode lets you add the atmosphere of a live concert or hall to almost any type of program source. These modes are particularly effective when used with stereo program sources, like CD, television, and FM radio. You might enjoy trying the ARENA, JAZZ CLUB, THEATER, STADIUM or DISCO mode the next time you watch a concert or sporting event!

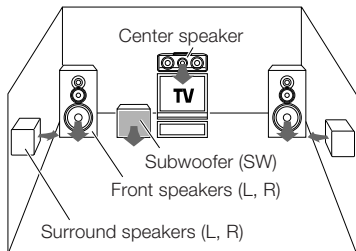

**What's DSP?**

DSP stands for Digital Signal Processor. The way a sound is heard in an actual environment depends on a variety of different factors. One of the most important is reverberation (the act of decaying elements of sound echoing in various places). The DSP modes produce the feeling of presence by using the DSP to create reverberation, without spoiling the sound quality of the original signal.

**DVD 6-channel mode**

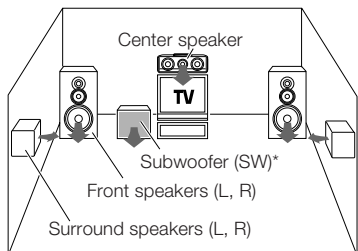

Using a DVD player or the like equipped with six (5.1) output channels and the receiver, you can enjoy multi-channel encoded DVD source material in all its splendor. Since the source signals are digital and each channel is input independently, the resulting sound quality, sense of spaciousness, and dynamic range are superb.



\* LFE = Low Frequency Effects. This channel delivers separate non-directional bass signals to the subwoofer for more dynamic deep bass sound effects.

## Surround Play

The DTS compatible models can reproduce a CD, DVD, or LD carrying the DTS mark.

DOLBY DIGITAL can be used when playing DVD or LD software bearing the  mark and DOLBY DIGITAL format digital broadcasts (etc.). DOLBY PRO LOGIC and DOLBY 3 STEREO can be used when playing video, DVD, or LD software bearing the  mark.

SRS Circle Surround enables you to listen to multi channel sound from the stereo source.

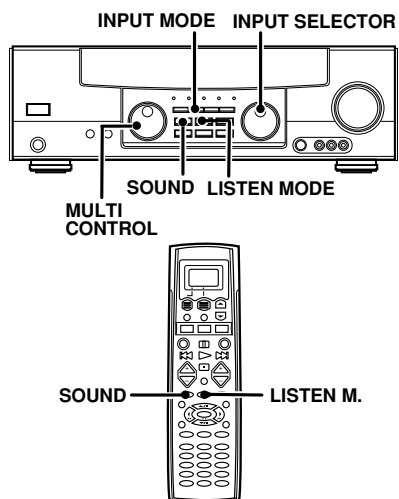

### Preparations

- Turn ON related components.
- Complete "Preparing for surround sound" (speaker settings). → [22]
- Use the **INPUT SELECTOR** to select the component you wish to play back with surround sound.
- Use the **INPUT MODE** key to select the input mode (analog or digital) for the source you wish to play back. → [7]
- Noise will be produced when a DTS source is played by selecting the analog input.

### 1 Start playing the video software.

### 2 Press the LISTEN MODE (LISTEN M.) key to select the listening mode.

The listening mode settings are stored separately for each input. If the input mode is set to digital auto ("AUTO SOUND" lights), the receiver selects the optimal listening mode automatically based on the type of input signal and the speaker settings.

Each press of the LISTEN MODE (LISTEN M.) key switches the setting as listed below.

The listening mode settings are different depending on the type of input signal.

#### When the DOLBY DIGITAL signal is input:

(The DOLBY DIGITAL, PRO LOGIC, or 3 STEREO indicator lights up.)

- 1 **DOLBY DIGITAL**: DOLBY DIGITAL surround (The DOLBY DIGITAL indicator lights up.)
- 2 **PL II MOVIE**: PRO LOGIC II surround MOVIE mode (The PRO LOGIC indicator lights up.)
- 3 **PL II MUSIC**: PRO LOGIC II surround MUSIC mode (The PRO LOGIC indicator lights up.)
- 4 **PRO LOGIC**: PRO LOGIC II surround PRO LOGIC mode (The PRO LOGIC indicator lights up.)
- 5 **3 STEREO**: 3-STEREO mode (The 3 STEREO indicator lights up.)
- 6 **STEREO**: Normal stereo playback.

#### When you select DOLBY DIGITAL

"DOLBY DIGITAL" will be scrolled from right to left.

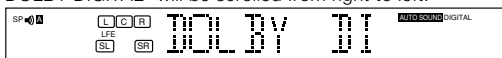

When the DTS signal is input: (The DTS indicator lights up.)

- 1 **DTS**: DTS surround
- 2 **STEREO**: Normal stereo playback

#### When the analog signal or the digital signal (except for DOLBY DIGITAL or DTS signal) is input:

- 1 **PL II MOVIE**: PRO LOGIC II surround MOVIE mode (The PRO LOGIC indicator lights up.)
- 2 **PL II MUSIC**: PRO LOGIC II surround MUSIC mode (The PRO LOGIC indicator lights up.)
- 3 **PRO LOGIC**: PRO LOGIC II surround PRO LOGIC mode (The PRO LOGIC indicator lights up.)
- 4 **3 STEREO**: 3-STEREO surround.
- 5 **CIRCLE SURROUND**: CS 5.1 surround (The CS 5.1 indicator lights up.)
- 6 **ARENA**: DSP Surround ARENA mode (The DSP MODE indicator lights up.)
- 7 **JAZZ CLUB**: DSP Surround JAZZ CLUB mode (The DSP MODE indicator lights up.)
- 8 **THEATER**: DSP Surround THEATER mode (The DSP MODE indicator lights up.)
- 9 **STADIUM**: DSP surround STADIUM mode (The DSP MODE indicator lights up.)
- 10 **DISCO**: DSP surround DISCO mode (The DSP MODE indicator lights up.)
- 11 **STEREO**: Normal stereo playback. Sound is produced from the two front channels only.

- If Dolby Digital or DTS signal having more channels than the maximum number of playback channels available using the receiver's current settings is input, the DOWNMIX indicator on the front panel lights up and downmixing is performed to match the number of available channels.

### 3 Adjust the volume.

#### Notes

- Depending on the type of the signal or speaker setting, some listening modes cannot be selected.
- When playback is started, the sound may be cut or interrupted before the input source is confirmed as Dolby Digital.
- To enjoy Dolby Digital surround (as well as all the other listening modes) from a single component, be sure to use a Dolby Digital compatible source component. Connect the Dolby Digital compatible source component's Dolby Digital format digital audio signal to one of the **DIGITAL INPUT** jacks on the back of the receiver. Connect the normal audio signal correctly to the respective component's **AUDIO** jacks. → [8] → [9] → [10] → [12]
- **Dialogue Normalization (Dial Norm)** is a feature of Dolby Digital. It is able to automatically maintain the overall audio output level constant. When playing source material with Dolby Digital software encoding, a brief message will appear.



This message informs you that the source material has been recorded at a different level than usual. For example, "OFFSET +4" will scroll across the display to indicate that it had been automatically adjusted to the normal output. If this message does not appear, no adjustment will be made.



## DVD 6-channel playback

Using a DVD player or the like equipped with six (5.1) output channels and the receiver, you can enjoy surround sound playback.

When you try to play a disc other than Dolby Digital such as DTS CD, no sound is produced or, noise may be heard. To avoid this situation, make sure that you connect the component to the receiver's DVD/6ch. INPUT jacks through a surround processor which can decode the surround signal you want to listen to.

Connecting a DVD player which can decode the surround signal itself is also acceptable.

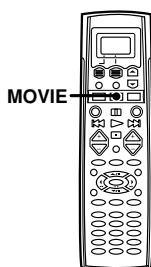
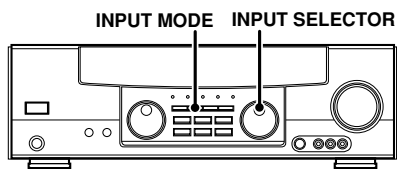

### Preparations

- Connect your DVD player to the DVD/6ch jacks of the receiver.
- Turn on all other components that will be used.
- Complete "Preparing for surround sound". - [22]

**1 Use the INPUT SELECTOR to select "DVD/6ch" or MOVIE key on remote control (if it was registered beforehand) as the input source.**

- If speaker system B is ON when "DVD/6ch" is selected as the input source, it switches off and speaker system A turns on automatically.

**2 Select "6ch INPT" by pressing the INPUT MODE key.**

**3 Start playback of the DVD software.**

**4 Adjust the volume.**

- It is not possible to adjust the volume level or sound quality (SET UP, SOUND) of the channels separately when the receiver is in the DVD/6ch mode. Adjust the volume with the controls of the DVD player. For the powered subwoofer, you can adjust the volume of the subwoofer using the subwoofer's own volume control.

## Convenient functions

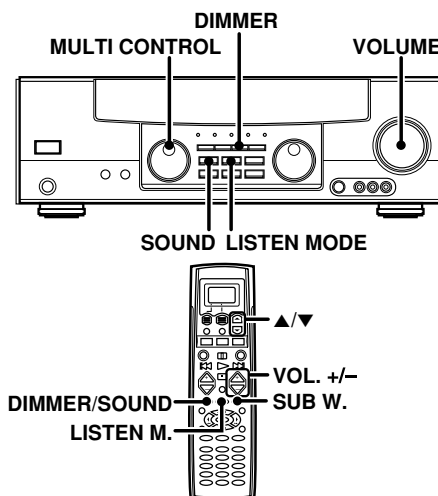

### Adjusting the sound

You can make further adjustments to the sound while listening to playback in the surround mode.

**1 Press the SOUND key until the desired item appears in the display.**

**Each time you press the button, the menu changes as follows: Note that some items are not displayed in certain modes.**

- ① **BASS** (low frequency range sound quality adjustment -PCM and analog stereo modes only) - [25]
- ② **TREB** (high frequency range sound quality adjustment -PCM and analog stereo modes only) - [25]
- ③ **C** (center speaker level adjustment)
- ④ **SR** (right surround speaker level adjustment)
- ⑤ **SL** (left surround speaker level adjustment)
- ⑥ **SW** (subwoofer level adjustment)
- ⑦ **INPUT** (input level adjustment - analog mode only) - [23]
- ⑧ **NIGHT** (midnight mode ON/OFF-Dolby Digital mode only)
- ⑨ **CINEMA** or **MUSIC** (Circle Surround mode only)
- ⑩ **PANORAMA** (Panorama mode ON/OFF\*)
- ⑪ **DIMENSION** (Dimension adjustment\*)
- ⑫ **CENTER WIDTH** (Center width adjustment\*)

\*Pro Logic II Music mode only

**2 Use the MULTI CONTROL knob or ▲/▼ keys to adjust the setting as desired.**

- The adjustment item is displayed for approximately 8 seconds.

### Midnight mode (Dolby Digital mode only)

When watching movies at night you might not be able to raise the volume as loud as normal. Midnight mode compresses the dynamic range of previously specified parts of the Dolby Digital sound track (like scenes with sudden increases in volume) to minimize the difference in volume between the specified and non-specified parts. This makes it easy to hear all of the sound track, even when listening at low volumes.

- ❶ Press the **SOUND** key repeatedly until “NIGHT” appears in the display.
  - This can be selected only if **CD/DVD**, **DVD/6ch**, **VIDEO2** or **VIDEO3** is selected as the source and the listen mode is set to “DOLBY DIGITAL”.
- ❷ Use the **MULTI CONTROL** knob or **▲/▼** keys to select the **ON** or **OFF** setting.



- The adjustment item is displayed for approximately 8 seconds.
- Some Dolby Digital software may not be compatible with the Midnight mode.

### Circle surround mode

When you enjoy multi sound from the stereo source (Circle Surround), you can select the circle surround mode.

- ❶ Press the **LISTEN MODE (LISTEN M.)** key so that “CIRCLE SURROUND” is displayed.
- ❷ Press the **SOUND** key so that “CINEMA” or “MUSIC” is displayed.
- ❸ Use the **MULTI CONTROL** knob or **▲/▼** keys to select “CINEMA” (for movies) or “MUSIC” (for music).

### Panorama mode (Pro Logic II Music mode only)

When listening to music, you will be able to enjoy the “wraparound” sound effect when you adjust the panorama mode.

- ❶ Press the **SOUND** key repeatedly until “PANORAMA” appears in the display.

- The PANORAMA setting indication scrolls across the display.

“PANORAMA” will be scrolled from right to left.



- ❷ Use the **MULTI CONTROL** knob or **▲/▼** keys to select **PANORAMA ON** or **OFF**.

- ➔ ❶ **ON** :PANORAMA mode is ON.
- ➔ ❷ **OFF** :PANORAMA mode is OFF.



### Dimension mode (Pro Logic II Music mode only)

When listening to music with certain recordings, you will also be able to achieve a suitable balance from all the speakers by adjusting the dimension mode.

- ❶ Press the **SOUND** key repeatedly until “DIMENSION” appears in the display.
  - The DIMENSION indication scrolls across the display.
- ❷ Use the **MULTI CONTROL** knob or **▲/▼** keys to adjust the soundfield towards the rear or the front.

Soundfield is adjusted towards the front.

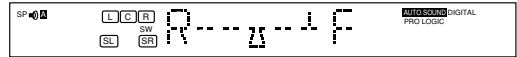

Soundfield is in neutral position.



Soundfield is adjusted towards the rear.



### Center width mode (Pro Logic II Music mode only)

Center width adjustment allows you to enjoy an enhanced sound when listening to music through center image from only center speaker, or left and right speakers or various combinations adjustments.

- ❶ Press the **SOUND** key repeatedly until “CENTER WIDTH” appears in the display.
  - The CENTER WIDTH indication scrolls across the display.
  - When the center speaker is switched OFF, this mode will not be effective.
- ❷ Use the **MULTI CONTROL** knob or **▲/▼** keys to adjust the left-center-right output.

Center image will be heard from center speaker only.



Center image will be heard from left and right speakers only.

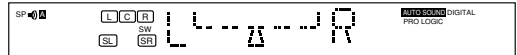

- When in other positions, center image from center speaker, left and right speakers can be heard simultaneously with various combinations.

### SUBWOOFER adjustment

It is easy to adjust the volume of the subwoofer using the remote control.

- 1 Press the **F. SHIFT** key, then press the **SUB W.** key on the remote control so that "SW" is displayed.

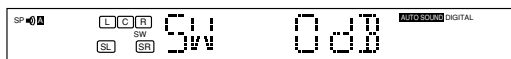

- 2 Use the **VOLUME** keys (**VOL. +/-** keys) to adjust the volume.
  - The adjustable range is -10 dB to +10 dB.

### Display dimmer adjustment

The dimmer function lets you select the brightness of the receiver's display. You might find this useful if you darken your room to watch movies or listen to music.

**Each time you press the DIMMER key, the display brightness changes among the three available settings. Select the brightness level you find most pleasing.**

When using the remote control unit, press **F. SHIFT** key, then press **DIMMER** key.

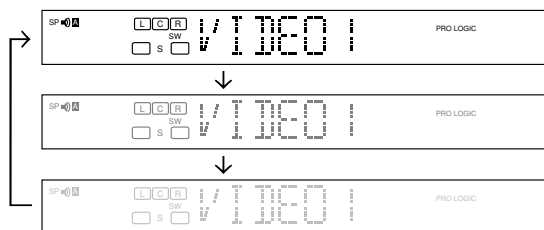

### 96kHz LPCM playback

The receiver is compatible with the 96kHz LPCM playback. To play a 96kHz DVD, set the listen mode to "STEREO".

- When "96kHz" appears in the display, press the **LISTEN MODE** key (the listen mode changes to the STEREO mode).

## Registering setup codes for other components

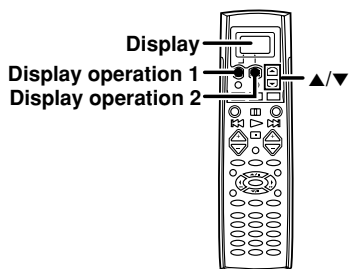

**1** Press the display operation 1 key repeatedly until "Menu" appears in the display.

```
Video1:
UCR
Menu
```

For step 1 through step 2, make sure you start the next step within 8 seconds of completing the previous one. If more than 8 seconds elapses between any two steps, press the display operation keys so that the display appears.

**2** Press the display operation 2 [Menu] key repeatedly until "01. IR" appears in the display.

- The setup display appears.

```
*01. IR
02. Surround
Home Enter
```

**3** Press the ▲/▼ keys to select "01. IR", then press the display operation 2 [Enter] key.

- The input selecting display appears.

```
*03. Video1
04. Video2
Back Enter
```

- At this time all inputs become available regardless of any earlier registration.

**4** Press the ▲/▼ keys to select the input that you want to register.

- Each time you press the ▲/▼ key, the input changes as follows:

```
01: CD/DVD
02: MD/Tape
03: Video1
04: Video2
05: Video3
06: DVD
07: TV1
08: TV2
09: Cable
10: Phono
```

- Example: To select the source connected to the VIDEO1 jack, select "Video1".

**5** Press the display operation 2 [Enter] key.

- The source selecting display appears.
- When you select "Phono" in step 4, go to step 10.

```
*05. UCR
06. Cable
Back Enter
```

**6** Press the ▲/▼ keys to select the source you want to register.

- Each time you press the ▲/▼ key, the input changes as follows:

```
01: CD
02: Tape
03: MD
04: CD-R
05: UCR
06: Cable
07: Satellit
08: TV
09: LD
10: DVD
11: DSS
12: No type
13: Delete
```

- Select "No type" when the desired source does not appear in the display.
- The selected input does not appear when you select "Delete".

**7** Press the display operation 2 [Enter] key.

- The maker selecting display appears.

```
*Kenwood
Admiral
Back Enter
```

**8** Press the ▲/▼ keys to select the maker you want to register.

- Press the ▲/▼ keys until the desired maker appears in the display. When the desired maker does not appear, select "Nothing".

**9** Press the display operation 2 [Enter] key.

- The setup code selecting display appears.

```
*01:0056
02:Nothing
Back Enter
```

**10** Press the ▲/▼ keys to select the setup code.

**11** Press the AV POWER I/⏻ key, and check to see that the component you want to control turns on.

If the component does not react, and there is more than one setup code, enter another setup code and try again.

- If the component is already on, pressing the AV POWER I/⏻ key will turn it off.

**12** Press the display operation 2 [Enter] key.

- The display returns to the setup display.

```

*01. IR
 02. Surround
Home Enter
  
```

Repeat steps 9 to 12 to register additional components until all components have been registered.

To return to the initial display, press display operation 1 [HOME] key repeatedly until "Menu" appears in the display.

```

Video1:
VCR
Menu
  
```

- Once registered, the display on the receiver shows the component type instead of the default input name. Example: if you register a VCR at the VIDEO 1 jacks, "Video1" and "VCR" appear in the display.
- Any VIDEO or TV (TV1, TV2, CABLE) inputs that have not been programmed with a setup code or Non-IR code are deleted from the cyclic list.

**When you make a mistake**

Press the **display operation 1 [Back]** key repeatedly until the display you want to re-operate appears.

**Note**

Although each setup code is designed to work with a number of different models, certain codes may not work with some models. (Also, certain codes may only operate some of the functions available on a given model.)

**Operating other components**

This operation lets you operate the registered components. KENWOOD audio components with system control turn on and off automatically with the receiver via the system control connections.

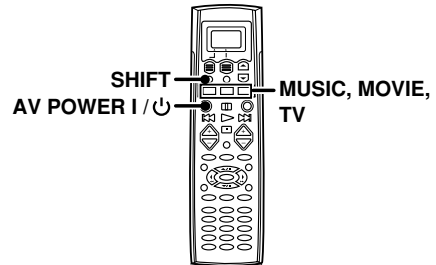

During operation, make sure you start the next step within 8 seconds of completing the previous one. If more than 8 seconds elapse between any two steps, press the display operation key so that the display appears.

**1** Use the **MUSIC**, **MOVIE**, or **TV** key to select the component you desire.

- Pressing the **MUSIC** or **MOVIE** key also changes the input selector on the receiver. If you do not want to change the current input, press the **SHIFT** key before step 1.

**MUSIC key**

- ① CD/DVD
- ② TAPE or MD
- ③ Tuner
- ④ PHONO

**MOVIE key**

- ① Video1
- ② Video2
- ③ Video3
- ④ DVD 6CH
- ⑤ AV AUX

**TV key**

- ① TV1
- ② TV2
- ③ CABLE

```

Video1:
VCR
Menu
  
```

Select source

- You cannot select the source that is not registered.

**2** Press the **AV POWER I/O** key.

- The selected component turns on or off.

**3** Press the operation keys you desire.

- See "Remote control operation of other components" at the end of this manual for a list of keys available with each component. → 43

The remote control mode remains in the set at the component selected in step 1 mode until you select another component.

**Note**

Be sure to point the remote control at the remote sensor on the receiver when you want to operate KENWOOD components connected by system control cords. Otherwise, point the remote control at the component you want to operate.

## Changing (confirming) the operation mode

This operation lets you change the remote control operation mode without changing the input selector.

You may find this useful when you want to control one component while using another. (For example, if you want to rewind the tape deck while listening to a CD.)

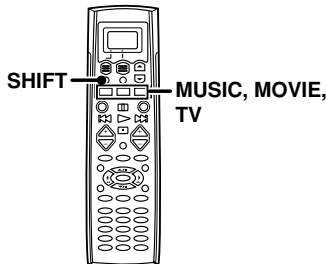

During operation, make sure you start the next step within 8 seconds of completing the previous one. If more than 8 seconds elapse between any two steps, press the display operation key so that the display appears.

### 1 Press the SHIFT key.

- "Shift" appears in the display.

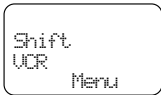

- To operate a TV, start from step 2.

### 2 Press the MUSIC, MOVIE, or TV key repeatedly to display the remote control mode for the component you want to control.

Press the MUSIC, MOVIE, or TV key until the desired source appears.

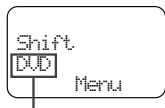

The component to be controlled

- Pressing any other keys after the SHIFT key cancels the shift function and sends the normal code associated with the respective key.
- The input selector does not change during this operation.

### 3 Execute the desired operations.

- See "Remote control operation of other components" for a list of keys available with each component. → [43]

The operation mode remains set at the component specified in step 2.

To return control to the original component, press SHIFT and then press the MUSIC or MOVIE key to return to the original control mode.

## Preparing for automatic operations (MACRO play)

The macro play function allows you to set the remote to control several components in succession. After completing this setup, you can perform a series of operations automatically. Enter the setup codes for the components you want to control beforehand.

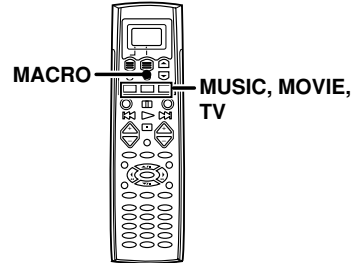

During operation, make sure you start the next step within 8 seconds of completing the previous one. If more than 8 seconds elapse between any two steps, the remote control unit exits from the MACRO play mode.

### 1 Make a plan of the macro play you want to Setup.

The order of the operations may be fairly complex and you may not remember all of the necessary commands during the setup procedure. Use the space provided below to write down the operations in the order you are going to enter them.

- Up to 20 steps can be memorized for each macro.

1		11	
2		12	
3		13	
4		14	
5		15	
6		16	
7		17	
8		18	
9		19	
10		20	

- The example below shows the plan for step 4 (which occupies a total of 6 steps) :

① TV + AV. POWER	2 steps
② FUNCTION SHIFT + 3	2 steps
③ MOVIE	1 steps
④ AV. POWER	1 steps
Total	6 steps

- If you attempt to store more than 20 steps, "Full" appears and exit the macro programming mode.
- Enter channel numbers (for the monitor TV, etc.) exactly as you would using the original remote.
- When you select the input by using the MUSIC, MOVIE, or TV key, it is counted as 1 step even if you press these keys repeatedly.

### 2 Press and hold the MACRO key for more than 2 seconds.

- "MACRO MEMORY" appears in the display.

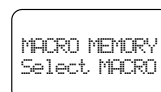

### 3 Press the **MUSIC**, **MOVIE**, or **TV** key to select the macro location. (**MACRO1**, **2**, and **3** respectively)

- You can store up to 3 different macros, one at each key:  
**MUSIC** → "MACRO 1", **MOVIE** → "MACRO 2", **TV** → "MACRO 3"
- Pressing a key other than **MUSIC**, **MOVIE**, or **TV** cancels the macro program mode.

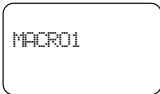

When **MUSIC** is pressed.

### 4 Press the keys to be operated in order.

#### EXAMPLE:

This example shows you how to create a macro that; turns on the TV, sets the TV to the appropriate input, selects the receiver's input selector to LD, and turns on the LD player. All you have to do is insert the laser disc!

- Press the **TV** key, then press the **AV POWER** | / **⏻** key to turn on the TV.
  - Press the **F. SHIFT** key, then press the "3" (**INPUT SEL.**) key to set the TV to the appropriate video input.
  - Press the **MOVIE** key to select the LD player registered at **VIDEO 2**.
  - Press the **AV POWER** | / **⏻** key to turn on the LD player.
- Make sure you start the next operation within 8 seconds of completing the previous one. If more than 8 seconds elapses between any two steps, exit the macro programming mode.
  - In order to allow verification of the remote control mode, the name of the selected input appears in the receiver's display when the **MUSIC**, **MOVIE**, or **TV** key is pressed. When the **MUSIC** or **MOVIE** key is pressed the receiver's input also changes.

### 5 Press the **MACRO** key.

- The macro is stored at the locations specified in step 3. If another macro was previously stored at the same location, it is erased.

Repeat steps 1 through 5 to program up to 3 macros.

This completes the macro programming procedure.

## Executing an automatic operation

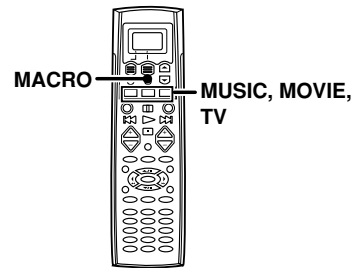

During operation, make sure you start the next step within 8 seconds of completing the previous one. If more than 8 seconds elapses between any two steps, press the display operation key so that the display appears.

### 1 Press the **MACRO** key.

- "MACRO EXE" appears in the display.

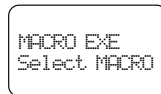

### 2 Press the **MUSIC**, **MOVIE**, or **TV** key to execute the corresponding macro play.

- "MACRO EXE" appears in the display and the pre-programmed macro is performed:  
**MUSIC** → "MACRO 1", **MOVIE** → "MACRO 2", **TV** → "MACRO 3"
- Some devices take up to 1 second to power on. The macro function has an automatic delay after any power function output.
- Pressing a key other than **MUSIC**, **MOVIE**, or **TV** cancels the macro program mode.

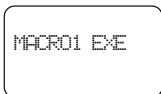

When **MUSIC** is pressed.

## To delete the setup code

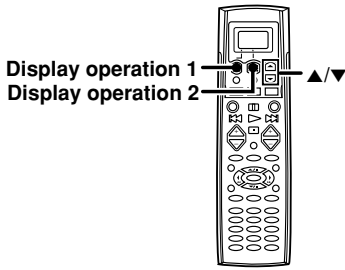

During operation, make sure you start the next step within 8 seconds of completing the previous one. If more than 8 seconds elapse between any two steps, press the display operation key so that the display appears.

- 1 Press the display operation 1 key repeatedly until "Menu" appears in the display.

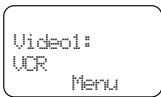

- 2 Press the display operation 2 [Menu] key repeatedly until "01. IR" appears in the display.

- The setup display appears.



- 3 Press the ▲/▼ keys to select "01. IR", then press the display operation 2 [Enter] key.

- The input selecting display appears.



- 4 Press the ▲/▼ keys to select the input that you want to delete, then press the display operation 2 [Enter] key.

- 5 Press the ▲/▼ keys to select "Delete".

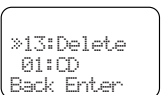

- 6 Press display operation 2 [Enter] key.

- The setup code is deleted.

## Storing the remote control code of the other components

The remote control unit can store the remote control code of the other components and you can operate the other components from the remote control unit. The remote control code is stored on the key or memory of the remote control unit.

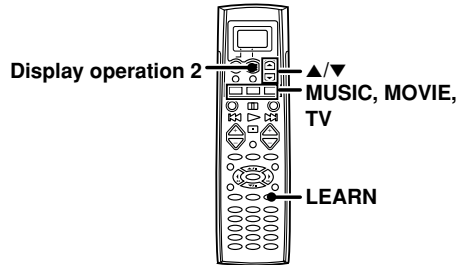

### Storing on the key

You can store the remote control code to the key as shown below:

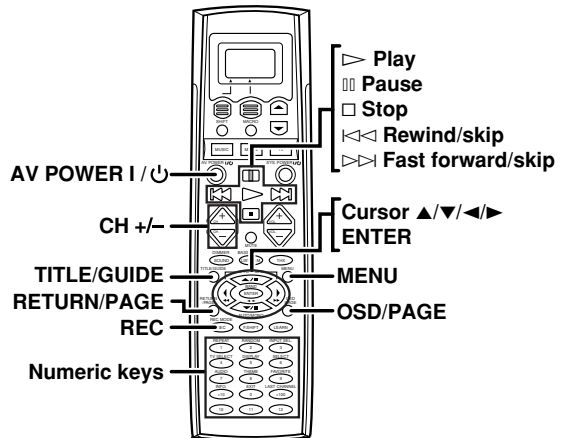

- 1 Point the infrared ray system part of another remote control unit to the remote sensor of the remote control unit.

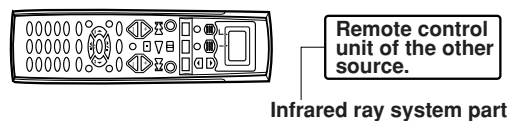

- 2 Press the MUSIC, MOVIE, or TV key to select the input of the desired remote control unit.

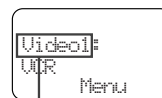

Selected input

- 3 Press the LEARN key.

- 4 Press the desired key of the remote control unit.

- The remote control is ready for receiving the remote control code.

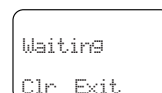



⑤ From the remote control unit of the other source, press the key that you want to store.

- The remote code is sent to the remote control unit.
- "Complete" appears when finished.



- When it takes for more than 5 seconds or the remote control unit does not receive the remote control code well, "Error" appears in the display. In this case, re-operate from step ①.

⑥ The remote control code is stored on the key of the remote control unit.

**To delete the memory stored on the key**

Press the display operation 1 [Clr] key in step ④. "Cleared" appears in the display. The memory previously stored is cleared.

**To operate other components**

- ① Press the MUSIC, MOVIE, or TV key to select the desired input source.
- ② Press the desired key.

**Storing on the memory**

You can store on the remote control unit up to 5 memories.

① Point the infrared ray system part of the other remote control unit to the remote sensor of the remote control unit.

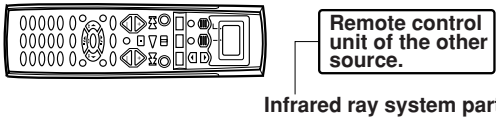

② Press the MUSIC, MOVIE, or TV key to select the input of the desired remote control unit.

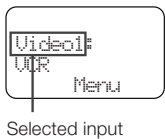

③ Press the LEARN key.

- The Extend selecting display appears.

When the setup code is registered



- When the setup code is not registered, any messages do not appear.

④ Press the ▲/▼ keys to select the location.

- Extend1 - Extend5 are available.

⑤ Press the display operation 2 [Enter] key.

- The remote control is sent for receiving the remote control code.

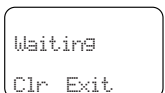

⑥ From the remote control unit of the other source, press the key that you want to store.

- The remote code is sent to the remote control unit.
- "Complete" appears when finished.

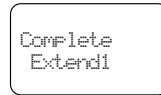

- When it takes for more than 5 seconds or the remote control unit does not receive the remote control code well, "Error" appears in the display. In this case, start from the step ① again.

⑦ The remote control code is stored on the memory (Extend1 - Extend5) of the remote control unit.

**To delete the stored memory**

Press the display operation 1 [Clr] key in step ⑤. "Cleared" appears in the display and the memory that is selected in step ④ is erased.

**To operate other components by using the stored memory**

- ① Press the MUSIC, MOVIE, or TV key to select desired input source.
- ② Press the display operation 2 [Menu] key during "Menu" appears in the display.
  - The Menu display appears.
- ③ Press the ▲/▼ keys to select the memory you want to operate.
- ④ Press the display operation 2 [Enter] key.

**Restoring the original factory settings**

You can restore the setup codes or memories to their original default settings.

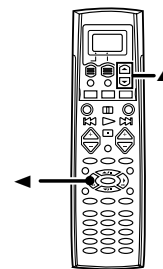

**Insert the batteries while pressing and holding the ▲ key and ◀ key.**

- "Cleared" appears in the display, and the remote settings return to their original default settings.
- To maintain the memory settings, complete the battery replacement operation approximately within 10 minutes.

## Displaying the CD TEXT data

When you connect a KENWOOD CD player (CD-425M, CD-4700M, CD-4260M, DPF-J6030), you can display the CD TEXT data in the display of the remote control unit.

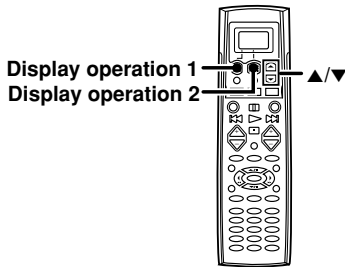

Before operation, register the setup code of the CD player.

### 1 Load the CD TEXT data to the CD player.

- 1 Press the MUSIC key to select "CD".
- 2 Press the display operation 2 [Menu] key repeatedly until "SetUp" appears in the display.
- 3 Press the ▲/▼ keys to select "All Read" and press the display operation 2 [Enter] key.
  - The loading time may take a while.

### 2 Load the CD TEXT data of the CD player to the remote control unit.

- 1 Press the MUSIC key to select "CD".
- 2 Press the display operation 2 [Menu] key repeatedly until "SetUp" appears in the display.
- 3 Press the ▲/▼ keys to select "Disc Title" and press the display operation 2 [Enter] key.
  - The remote control unit starts reading the CD TEXT data (disc titles are also read).
  -  appears during reading.

### 3 Press the [Home] key.

- "Text." appears when the CD TEXT data is read.

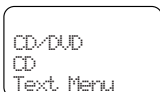

- When "Text." does not appear, select "Track Title" in the "SetUp" display and press the display operation 2 [Enter] key.

### 4 Press the display operation 1 [Text] key.

- The display for selecting disc appears.

```

×001: TitleA
  002: TitleB
Home Sel
  
```

### 5 Press the ▲/▼ keys to select the desired disc, then press the display operation 2 [Sel] key.

```

×01: Title1
  02: Title2
Back Sel
  
```

### 6 Press the ▲/▼ keys to select the desired track, then press the display operation 2 [Sel] key.

```

×05: Title5
  06: Title6
Back Sel
  
```

# Remote control operation of other components

You can operate other components by pressing keys or using the display. The setup code for each component must be entered beforehand. → 36

## When you operate by using the keys

- ❶ Press the **MUSIC, MOVIE, or TV** key to select the component you want to control.
- ❷ Press the keys corresponding to the operations you desire.

## When you operate by using the display

- ❶ Press the **MUSIC, MOVIE, or TV** key to select the component you want to control.
- ❷ Press the display operation 2 [Menu] key so that the Menu display appears.
- ❸ Press the **▲/▼** keys to select desired item or memory, then press the display operation 2 [Enter] key.

- To execute a **FUNCTION SHIFT** command key, press the **F. SHIFT** key, then press the corresponding key.
- When pressing keys in succession, press each key firmly and be sure to wait at least 1 second before pressing the next key.

### Notes

1. Although each setup code is designed to work with a number of different models, certain codes may not work with some models. (Also, certain codes may only operate some of the functions available on a given model.)
2. The charts below show the typical functions available for each component. Some manufacturers use different key combinations to perform similar functions.

## Satellite tuner operations

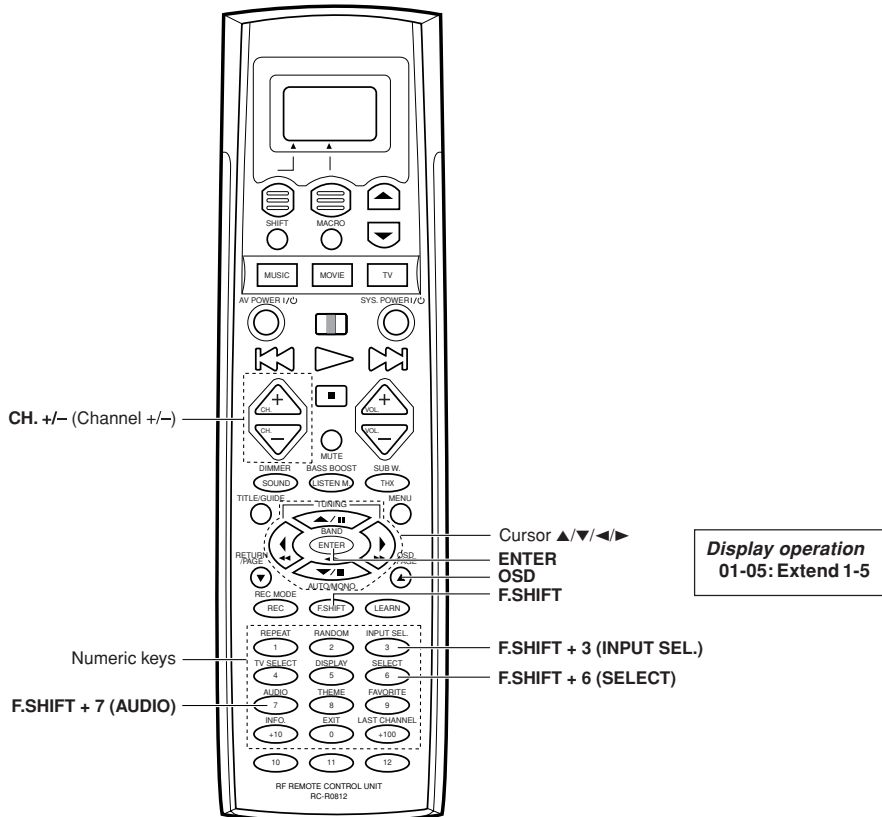

Cassette deck operations

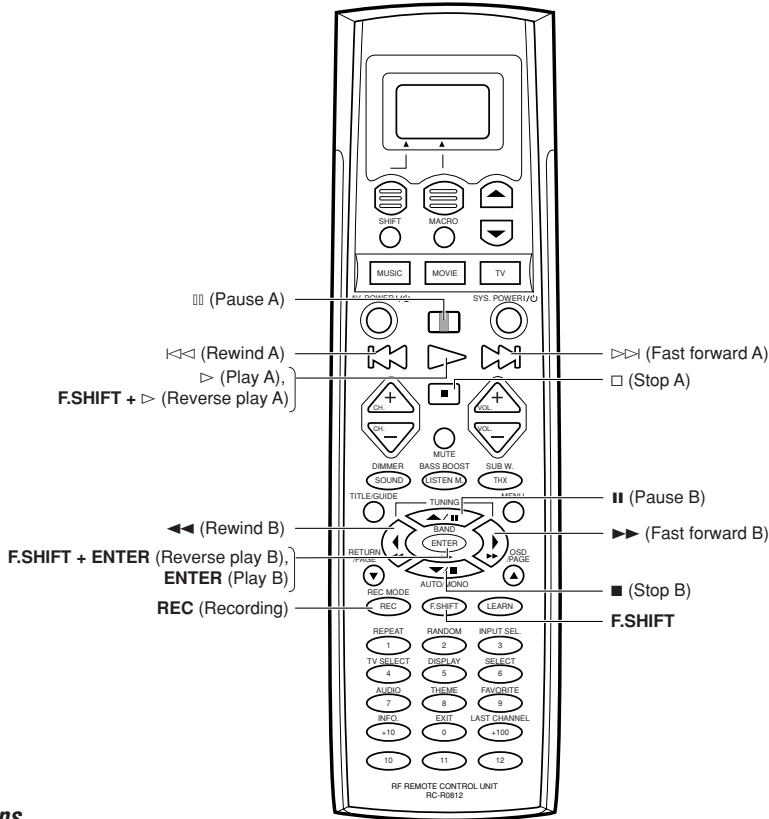

CD player operations

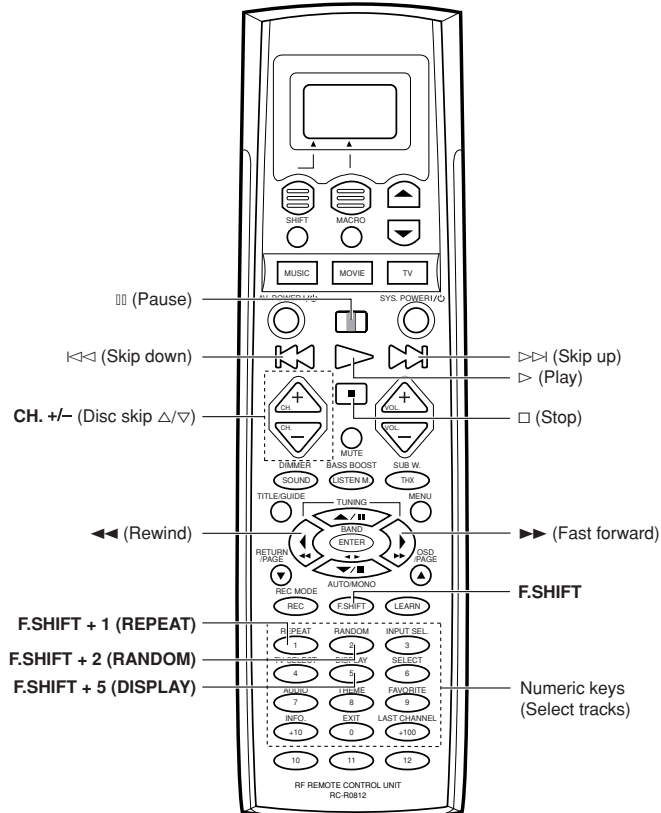

MD recorder operations

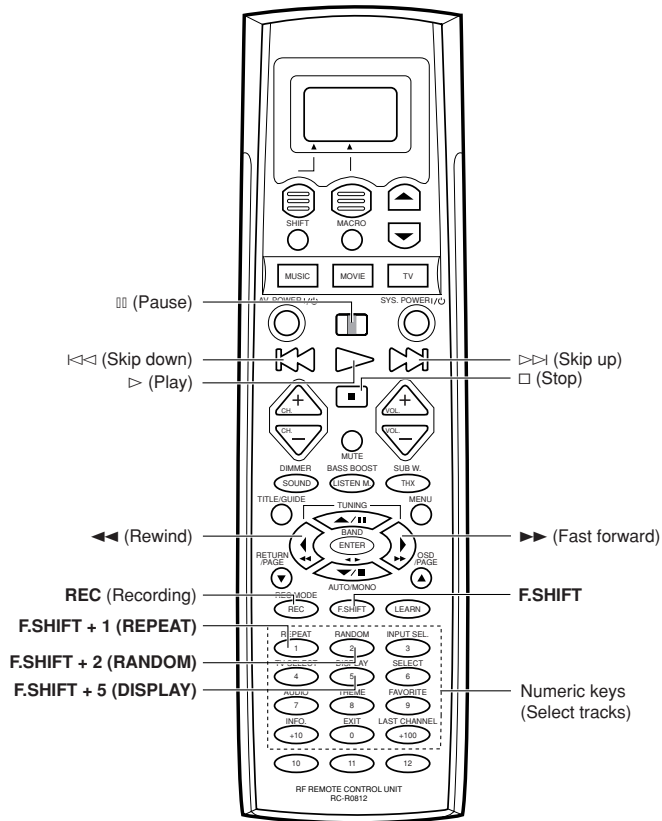

Display operation  
01-05: Extend 1-5

TV operations

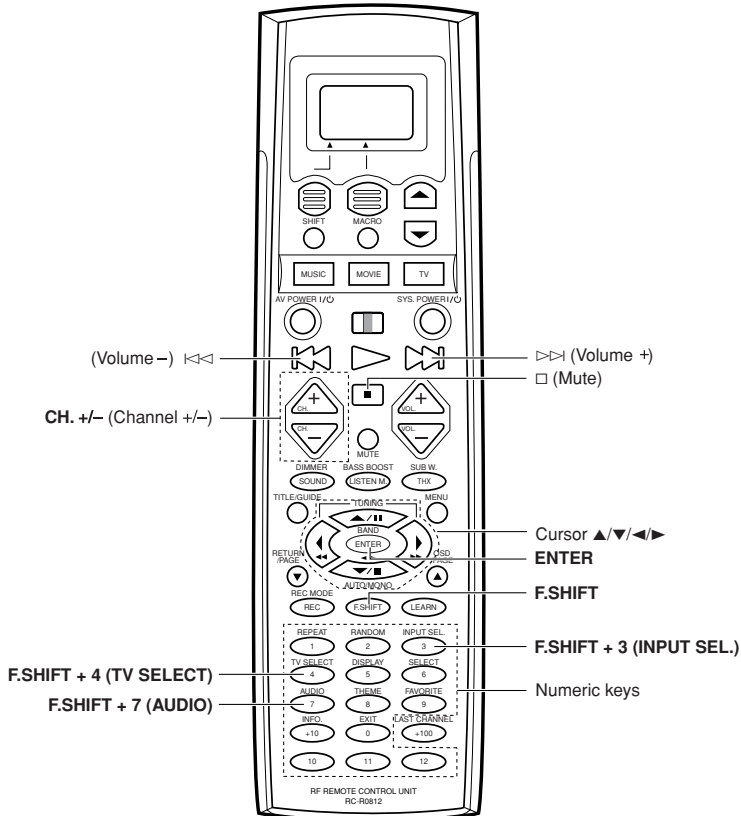

Display operation  
01: +/-  
02: >12  
03: Wide  
04: Picture in Picture  
05: Text/Mix/TV  
06: Text Off  
07: Mix  
08: Exit  
09-13: Extend 1-5

VCR operations

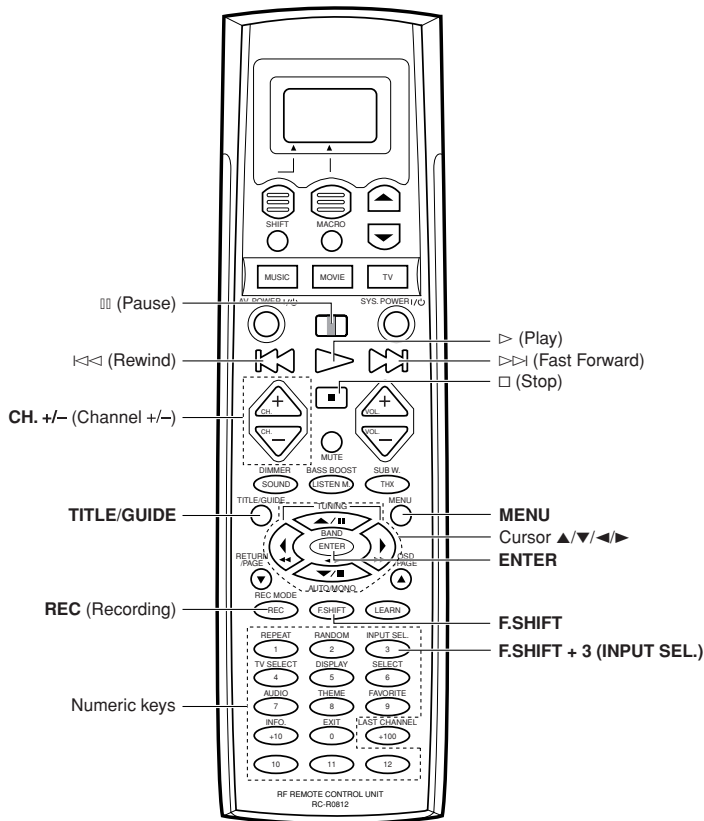

- Display operation**
- 01: Thumb Up
  - 02: Thumb Down
  - 03: Jump
  - 04: Instant Replay
  - 05: Quick Skip
  - 06: Exit
  - 07-11: Extend 1-5

LD player operations

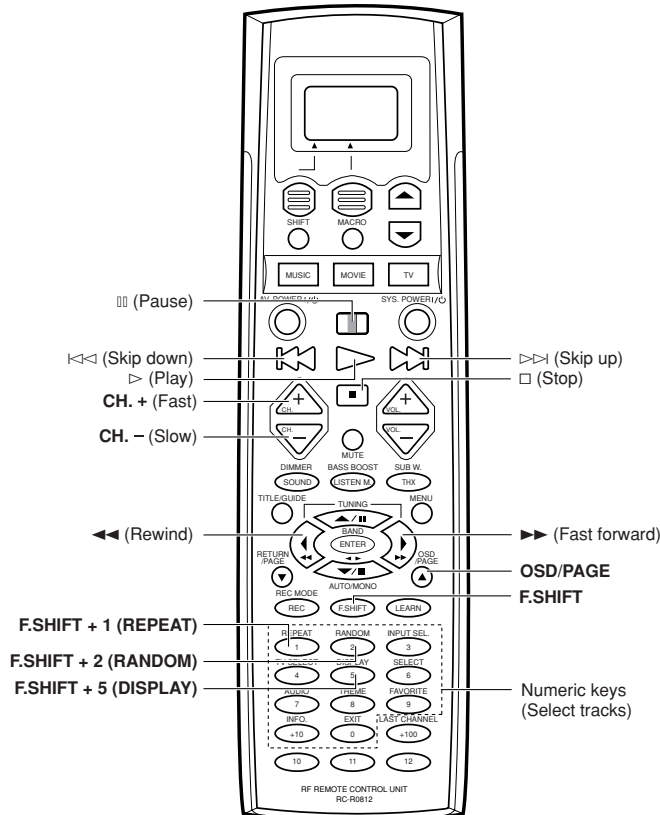

- Display operation**
- 01: Frame/Time
  - 02: Side A or A/B
  - 03: Side B
  - 04-08: Extend 1-5

DVD player operations

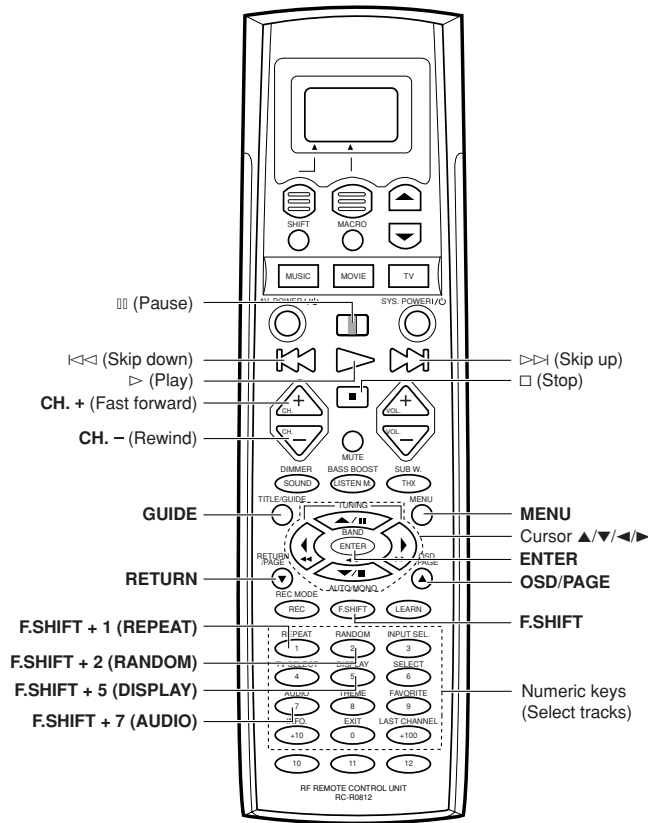

- Display operation**
- 01: Chapter/Time
  - 02: Angle
  - 03: PGM
  - 04: DVD Set
  - 05: Memory
  - 06: Clear
  - 07: Repeat A-B
  - 08: Sub Title
  - 09: Title Search
  - 10: Aspect
  - 11: On/Off
  - 12-16: Extend 1-5

DSS receiver operations

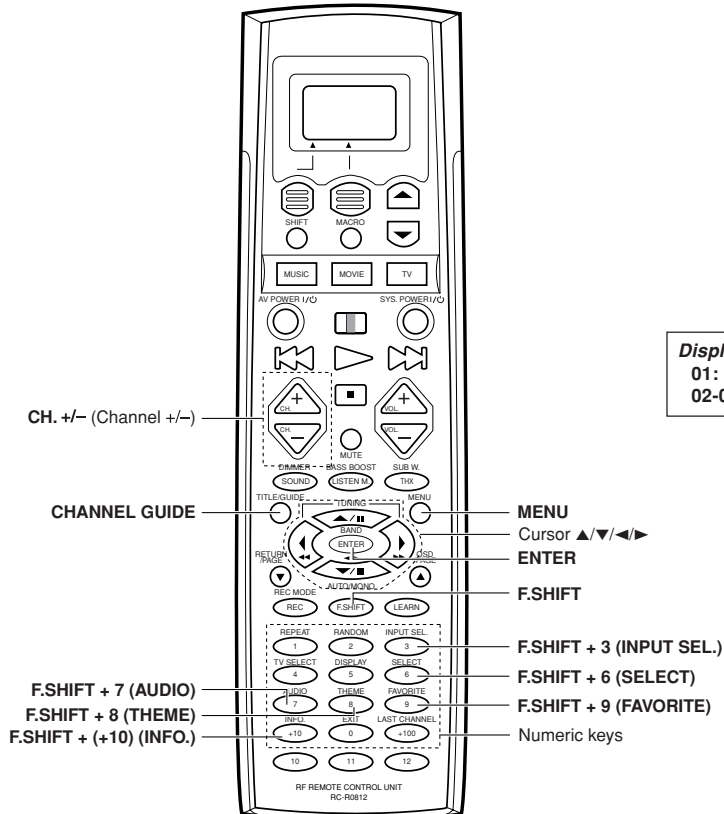

- Display operation**
- 01: Exit
  - 02-06: Extend 1-5

Cable tuner operations

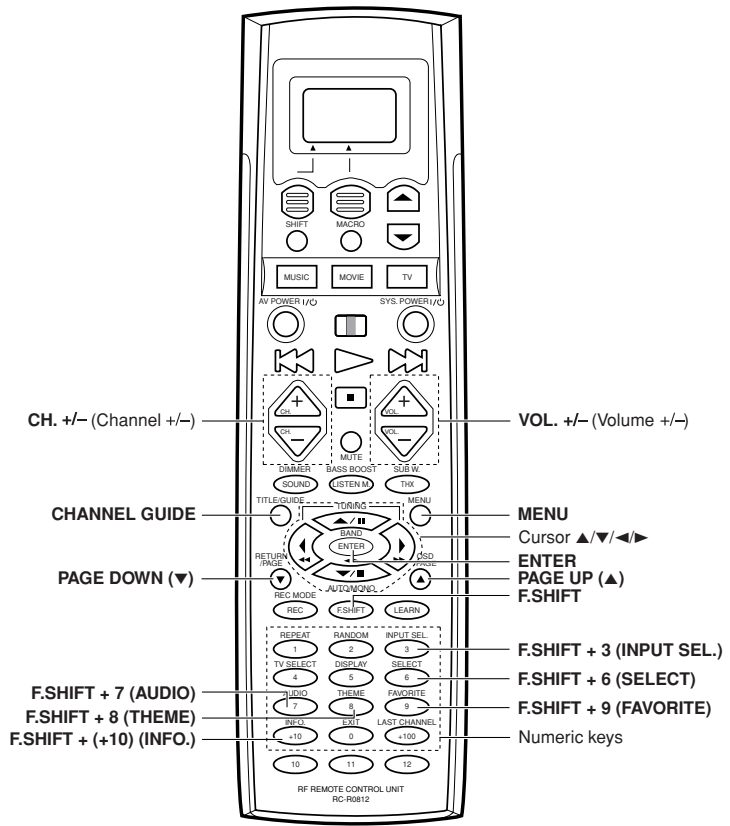

**Display operation**  
 01: A - B - C  
 04-08: Extend 1-5



## Resetting the Microcomputer

The microcomputer may malfunction (unit cannot be operated, or shows an erroneous display) if the power cord is unplugged while the power is ON, or due to some other external factor. If this happens, execute the following procedure to reset the microcomputer and return the unit to its normal operating condition.

**Unplug the power cord from the wall outlet, then plug it back in while holding down the STANDBY key.**

- Please note that resetting the microcomputer will clear the contents of the memory and returns the unit to the state it was in when it left the factory.

## Amplifier

Symptom	Cause	Remedy
<b>No sound from the speakers.</b>	<ul style="list-style-type: none"> <li>• The speaker cords are disconnected.</li> <li>• VOLUME is set to the minimum position.</li> <li>• MUTE is ON.</li> <li>• The SPEAKERS switches are set to OFF.</li> </ul>	<ul style="list-style-type: none"> <li>• Connect them properly referring to "Connecting the speakers". → [13]</li> <li>• Adjust the volume to a proper level.</li> <li>• Turn OFF the MUTE. → [25]</li> <li>• Set the SPEAKERS switch(es) to ON. → [24]</li> </ul>
<b>The standby indicator blinks and sound is not output.</b>	<ul style="list-style-type: none"> <li>• Speaker cords are short-circuited.</li> </ul>	<ul style="list-style-type: none"> <li>• Turn the power off, eliminate the short-circuiting, then turn on the power again.</li> </ul>
<b>Sound is not output from one of the speakers.</b>	<ul style="list-style-type: none"> <li>• The speaker cord is disconnected.</li> </ul>	<ul style="list-style-type: none"> <li>• Connect it properly referring to "Connecting the speakers". → [13]</li> </ul>
<b>Sound is not output from the surround speakers and / or the center speaker, or their sound is very small.</b>	<ul style="list-style-type: none"> <li>• The surround speaker cords and/or the center speaker cord is disconnected.</li> <li>• A surround mode has not been engaged.</li> <li>• The surround and/or center volume controls are set to the minimum level.</li> </ul>	<ul style="list-style-type: none"> <li>• Connect it properly referring to "Connecting the speakers". → [13]</li> <li>• Select a surround mode.</li> <li>• Adjust the speaker levels using the test tone. → [23]</li> </ul>
<b>A humming noise is generated when the PHONO input selector is selected.</b>	<ul style="list-style-type: none"> <li>• The audio cord from the turntable is not connected to the PHONO jacks.</li> <li>• The turntable is not grounded.</li> </ul>	<ul style="list-style-type: none"> <li>• Insert the audio cord plugs securely into the PHONO jacks.</li> <li>• Connect the grounding wire to the GND terminal on the rear panel.</li> </ul>
<b>When playing a Dolby Digital source signal using a DVD player, the sound is cut off soon after it starts.</b>	<ul style="list-style-type: none"> <li>• There are many possible causes for this problem, depending on the type of DVD player used.</li> </ul>	<ul style="list-style-type: none"> <li>• Set the input mode to digital manual before starting playback of the Dolby Digital source. → [7]</li> </ul>
<b>No sound is produced during playback from a DVD player.</b>	<ul style="list-style-type: none"> <li>• The input mode is set to digital manual.</li> </ul>	<ul style="list-style-type: none"> <li>• Press the INPUT MODE key to select to digital auto mode. → [7]</li> </ul>
<b>A video source cannot be recorded normally.</b>	<ul style="list-style-type: none"> <li>• The software is copy-guarded.</li> </ul>	<ul style="list-style-type: none"> <li>• Copy-guarded video software cannot be recorded.</li> </ul>

## Tuner

Symptom	Cause	Remedy
<b>Radio stations cannot be received.</b>	<ul style="list-style-type: none"> <li>• No antenna is connected.</li> <li>• The broadcast band is not set properly.</li> <li>• The frequency of the desired station is not tuned.</li> </ul>	<ul style="list-style-type: none"> <li>• Connect an antenna. → [18]</li> <li>• Set the broadcast band properly.</li> <li>• Tune the frequency of the desired station. → [27]</li> </ul>
<b>Interference.</b>	<ul style="list-style-type: none"> <li>• Noise due to ignition noise from an automobile.</li> <li>• Noise due to interference from an electric appliance.</li> <li>• Noise due to a nearby TV set.</li> </ul>	<ul style="list-style-type: none"> <li>• Install the outdoor antenna away from the road.</li> <li>• Turn off the power to the appliance.</li> <li>• Install the receiver farther away from the TV.</li> </ul>
<b>A station which was preset cannot be received by pressing the corresponding numeric key.</b>	<ul style="list-style-type: none"> <li>• The preset station belongs to a frequency that cannot be received.</li> <li>• The preset memory was cleared because the power cord had been unplugged for a long period of time.</li> </ul>	<ul style="list-style-type: none"> <li>• Preset a station with a receivable frequency.</li> <li>• Preset the station again.</li> </ul>

## Remote control unit

Symptom	Cause	Remedy
The battery indicator flashes during operation.	<ul style="list-style-type: none"> <li>The batteries are nearing exhaustion.</li> </ul>	<ul style="list-style-type: none"> <li>Replace with new batteries to preserve the currently registered setup information. → <a href="#">19</a></li> </ul>
Subwoofer volume cannot be adjusted.	<ul style="list-style-type: none"> <li>Subwoofer is OFF.</li> </ul>	<ul style="list-style-type: none"> <li>Turn the subwoofer ON. → <a href="#">22</a></li> </ul>
Certain inputs cannot be selected using the remote control.	<ul style="list-style-type: none"> <li>No setup codes registered at for the respective input(s).</li> </ul>	<ul style="list-style-type: none"> <li>Register a setup code or Non-IR code at the respective input(s). → <a href="#">36</a></li> </ul>
Remote control operation is not possible.	<ul style="list-style-type: none"> <li>The remote control is set to a different operation mode.</li> <li>Batteries are exhausted.</li> <li>The remote control unit is too far away from the main system, controlling angle is too large, or there is an obstacle between the receiver and the remote.</li> <li>The audio cords and system control cords are not connected properly.</li> <li>No software is loaded in the source component.</li> <li>An attempt is made to play a tape which is being recorded in the cassette deck.</li> <li>The remote control has not been set to the operation mode for the component you wish to control.</li> <li>The microprocessor of the remote control malfunctions.</li> </ul>	<ul style="list-style-type: none"> <li>Press the <b>MUSIC</b>, <b>MOVIE</b>, or <b>TV</b> keys to select the appropriate operation mode.</li> <li>Replace with new batteries. → <a href="#">19</a></li> <li>Operate the remote control unit within the controllable range.</li> <li>Connect properly referring to "Setting up the system". → <a href="#">7</a></li> <li>Place software in the source component you want to play.</li> <li>Wait until recording has completed.</li> <li>Press the <b>MUSIC</b>, <b>MOVIE</b>, or <b>TV</b> keys to activate the operation mode for the component you want to control before operation. → <a href="#">21</a></li> <li>Reset the microprocessor. → <a href="#">49</a></li> </ul>

## AUDIO section

Rated power output during STEREO operation

110 watts per channel minimum RMS, both channels driven, at 8 Ω from 20 Hz to 20 kHz with no more than 0.7% total harmonic distortion. (FTC)

Effective power output during SURROUND operation

FRONT (20-20kHz, 0.7% T.H.D. at 8 Ω one channel driven)	110 W + 110 W
CENTER (20-20kHz, 0.7% T.H.D. at 8 Ω one channel driven)	110 W
SURROUND (20-20kHz, 0.7% T.H.D. at 8 Ω one channel driven)	110 W + 110 W
Total harmonic distortion	0.045% (1 kHz, 55W, 8 Ω)
Frequency response	10 Hz ~ 60 kHz, +0 dB, -3.0 dB
CD	92 dB
Signal to noise ratio (IHF'66)	
PHONO (MM)	75 dB
CD	92 dB
Input sensitivity / impedance	
PHONO (MM)	4 mV / 27 kΩ
CD	300 mV / 47 kΩ
MONITOR IN	300 mV / 47 kΩ
DVD/6CH INPUT	300 mV / 47 kΩ
Output level / impedance	
TAPE REC	300 mV / 1 kΩ
MONITOR OUT	300 mV / 1 kΩ
PRE OUT (FRONT, CENTER, SURROUND)	1 V / 500 Ω
PRE OUT (SUBWOOFER)	1.8 V / 500 Ω
Tone control	
BASS	±10 dB (at 70 Hz)
TREBLE	±10 dB (at 10 kHz)

## DIGITAL AUDIO section

Sampling frequency	32 kHz, 44.1 kHz, 48 kHz, 96kHz
Input level / impedance / wave length	
Optical	(-15 dBm ~ -21 dBm), 660 nm ±30nm
Coaxial	0.5 Vp-p / 75 Ω

## VIDEO section

VIDEO inputs / outputs

VIDEO (composite)	1 Vp-p / 75 Ω
S VIDEO (luminance signal)	1 Vp-p / 75 Ω
(chrominance signal)	0.286 Vp-p / 75 Ω
COMPONENT VIDEO (luminance signal)	1 Vp-p / 75 Ω
(Cb/Cr - signal)	+/- 0.324 Vp-p / 75 Ω

## FM tuner section

Tuning frequency range	87.5 MHz ~ 108 MHz
Usable sensitivity (MONO)	1.3 μV (75 Ω) / 13.2 dBf (75 kHz DEV., SINAD 30 dB)
50dB quieting sensitivity	
STEREO	28 μV (75 Ω) / 40.2 dBf
Total harmonic distortion (1 kHz)	
MONO	0.5% (65 dBf input)
STEREO	0.7% (65 dBf input)
Signal to noise ratio (1 kHz, 75 kHz DEV.)	
MONO	75 dB (65 dBf input)
STEREO	68 dB (65 dBf input)
Stereo separation (1 kHz)	40 dB
Selectivity (±400 kHz)	70 dB
Frequency response	(30 Hz ~ 15kHz), +0.5 dB, -3.0 dB

## AM tuner section

Tuning frequency range	
10 kHz step	530 kHz ~ 1,700 kHz
Usable sensitivity	16 μV / (600 μV/m)
Signal to noise ratio (30% mod. 1 mV input)	50 dB

## GENERAL

Power consumption	2.6 A
AC outlet	
SWITCHED	(total 150 W, 1.25 A max.)
Dimensions	W : 440 mm (17-5/16")
	H : 144 mm (5-11/16")
	D : 399 mm (15-11/16")
Weight (Net)	8.75 kg (19.3 lb)

Notes  
 1. KENWOOD follows a policy of continuous advancements in development. For this reason specifications may be changed without notice.  
 2. The full performance may not be exhibited in an extremely cold location (under a water-freezing temperature).

---

# KENWOOD

***For your records***

Record the serial number, found on the back of the unit, in the spaces designated on the warranty card, and in the space provided below. Refer to the model and serial numbers whenever you call upon your dealer for information or service on this product.

Model \_\_\_\_\_ Serial Number \_\_\_\_\_